

# OPERATION MANUAL

# P-97

FLAMING/BROWN

MICROPIPETTE PULLER

REV. 0903 - DOM

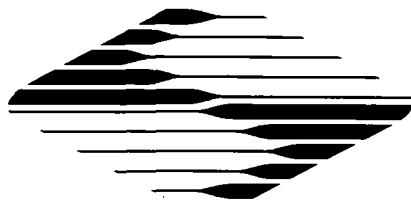

SUTTER INSTRUMENT COMPANY

P-97

**FLAMING/BROWN MICROPIPETTE PULLER**

**OPERATION MANUAL**

**(REV. 0903) DOM**

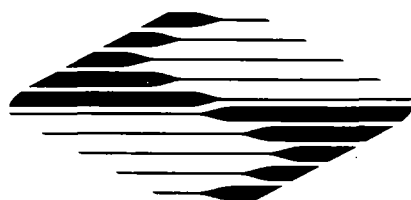

**MANUFACTURED BY  
SUTTER INSTRUMENT COMPANY  
51 DIGITAL DRIVE  
NOVATO, CA 94949  
U.S.A.**

**VOICE: 415-883-0128  
FAX: 415-883-0572**

**WEB: [HTTP://WWW.SUTTER.COM](http://www.sutter.com)  
EMAIL: [INFO@SUTTER.COM](mailto:info@sutter.com)**

## TABLE OF CONTENTS

<b>GENERAL INFORMATION</b> .....	<b>1</b>
TECHNICAL SUPPORT .....	1
WHAT'S NEW ON THE P-97? .....	1
<b>SAFETY WARNING</b> .....	<b>3</b>
<b>PRECAUTIONS</b> .....	<b>4</b>
ON OPERATION .....	4
ON HANDLING MICROPIPETTES .....	4
<b>GLASSWARE &amp; HEATING FILAMENT SPECIFICATIONS</b> .....	<b>5</b>
<b>UNPACKING</b> .....	<b>6</b>
<b>SETTING UP</b> .....	<b>7</b>
LINE POWER (MAINS) .....	7
<b>FIRST TIME USE</b> .....	<b>8</b>
<b>FRONT PANEL</b> .....	<b>10</b>
CONTROLS .....	10
DISPLAY .....	11
<b>MECHANICAL DESCRIPTION (PULLER ANATOMY)</b> .....	<b>13</b>
SOME BASIC INFORMATION .....	13
AIR COOLING SYSTEM .....	13
HEATING ASSEMBLY .....	14
UPPER CABLE PULLEY ASSEMBLY .....	15
CABINET .....	16
ELECTRONICS .....	16
<b>PROGRAMS</b> .....	<b>17</b>
PROGRAM STRUCTURE .....	17
CYCLE PARAMETERS .....	17
PULL CYCLE .....	19
DEFAULT CONFIGURATION .....	20
SELECTING A PROGRAM .....	20
VIEWING A PROGRAM .....	21
CLEARING A PROGRAM FROM MEMORY .....	21
EDITING A PROGRAM .....	22
<b>SOFTWARE CONTROL FUNCTIONS</b> .....	<b>23</b>
RAMP TEST < 1 > .....	24
CHANGE AIR PRESSURE < 2 > .....	25
AIR MODE < 3 > .....	25
AIR TIME AT START OF PULL < 4 > .....	26
AIR TIME AT END OF PULL < 5 > .....	26
RESET TIME AND DATE < 6 > .....	26
WRITE-PROTECT THE PROGRAM < 7 > .....	26
MEMORY TEST < 8 > .....	26

<b>PULLING PIPETTES .....</b>	<b>27</b>
PROCEDURES .....	27
NOTES ON PROGRAM OPERATION .....	28
<b>PARAMETER ADJUSTMENT .....</b>	<b>29</b>
GENERAL INFORMATION .....	29
MICROPIPETTE/MICROINJECTION NEEDLE FABRICATION .....	29
PATCH PIPETTE FABRICATION .....	31
TECHNICAL TIPS FOR PULLING MICROPIPETTES .....	35
FIRE POLISHING .....	36
<b>HEATING FILAMENTS .....</b>	<b>38</b>
GENERAL INFORMATION .....	38
TROUGH FILAMENT .....	38
BOX FILAMENT .....	39
<b>MAINTENANCE .....</b>	<b>41</b>
CLEANING .....	41
HEATING FILAMENT REPLACEMENT .....	41
PULLEY ADJUSTMENT .....	43
REGENERATION OF DRIERITE GRANULES .....	44
<b>TROUBLESHOOTING .....</b>	<b>46</b>
CONTROLLING PIPETTE TIP SHAPES .....	46
CONTROLLER PROBLEMS .....	48
TECHNICAL SUPPORT .....	49
<b>FUSE REPLACEMENT .....</b>	<b>50</b>
<b>LIMITED WARRANTY .....</b>	<b>51</b>
<b>DISCLAIMER .....</b>	<b>52</b>
<b>TECHNICAL SPECIFICATIONS .....</b>	<b>53</b>
<b>APPENDIX: A DRIERITE MATERIAL SAFETY DATA SHEET .....</b>	<b>54</b>
<b>INDEX .....</b>	<b>56</b>

## GENERAL INFORMATION

The P-97 can fabricate pipettes for use in intracellular recording, patch-clamping, microinjection and microperfusion. Realizing the full potential of this instrument is dependent on a complete understanding of the way it implements the pulling process. To this end, we urge that this manual be read in its entirety. To aid in understanding the function of the instrument, sample programs are already loaded in memory (as discussed in subsequent material).

The Model P-97 Flaming/Brown Micropipette Puller combines a proven pulling technology with programmability to produce a very versatile instrument. The pulling mechanism is derived from the P-77/P-80 series of pullers, which have demonstrated the ability to pull a complete range of pipette profiles. Added to this mechanism is the ability to program different pulling sequences; thus, allowing ease of use for pulling a multiplicity of pipettes on one device.

The P-97 is a 'velocity sensing' puller. This patented feature allows the puller to indirectly sense the viscosity of the glass, giving the P-97 the ability to pull pipettes from all glasses except quartz. Even difficult to pull formulations, such as aluminosilicate glasses, are handled with relative ease.

Throughout this manual reference will be made to the size of the glass tubing used to pull micropipettes. The convention used here for describing the outside diameter (O.D.) and inside diameter (I.D.) is as follows: O.D. x I.D. These dimensions will always be given in millimeters (mm). See our catalog or visit [www.sutter.com](http://www.sutter.com) to find a wide selection of glass capillaries available for purchase.

### Technical Support

Unlimited technical support is provided by Sutter Instrument Company at no charge to our customers. Our technical support staff is available between the hours of 8:00 AM and 5:00 PM (Pacific Standard Time) at (415) 883-0128. You may also E-mail your queries to [info@sutter.com](mailto:info@sutter.com).

### What's new on the P-97?

For users familiar with the P-80PC and/or P-87 pullers, the P-97 provides the advanced features incorporated into those instruments plus:

- Humidity controlled chamber surrounding the heating filament. Glass is now pulled in a constant humidity environment to minimize environmental effects on pipette reproducibility.
- Vacuum fluorescent display for improved readability
- 25% increase in available power
- Programmable air pressure
- Time of pull displayed at the end of each pull sequence

- Write protection to prevent programs from being corrupted
- Displayed date/time of last program edit
- Increased memory capable of storing 100 programs
- Switchable cooling mode to facilitate easy transfer of programs from both P-80PC and P-87 pullers

**SAFETY WARNING**

- **To prevent fire or shock hazard do not expose the unit to rain or moisture.**
- **To avoid electrical shock:**
  - Do not disassemble the unit. Refer servicing to qualified personnel.**
  - Always use the grounded power supply cord set provided to connect the unit to a grounded outlet (3-prong). This is required to protect you from injury in the event that an electrical hazard develops.**
- **To avoid burns do not touch the heating filament, the brass clamps holding the filament, or the heated ends of glass pipettes that have been pulled.**
- **To avoid injuring your back or limbs it is recommended that you do not attempt to lift this instrument by yourself. The P-97 Micropipette Puller weighs in excess of 18kg and should be moved by TWO people.**

## PRECAUTIONS

### On operation

Failure to comply with any of the following precautions may damage this device.

- Operate the P-97 using 110V a.c., 60Hz line voltage.
- The P-97 is designed to be operated in a laboratory environment (pollution degree II) and at temperatures between 5°C - 40°C.
- The P-97 is designed to be connected to a standard laboratory power outlet (overvoltage category II) with main supply voltage fluctuations not to exceed  $\pm 10\%$  of the normal voltage.
- This unit was not designed to be operated at altitudes above 2000 meters nor was it tested for safety above 2000 meters.
- This unit was designed to operate at maximum relative humidity of 80% for temperatures up to 31°C decreasing linearly to 50% relative humidity at 40°C.
- Operate only in a location where there is a free flow of fresh air on all sides. The fan draws air in through the vents on the sides and exhausts out both ends of the heat sink. **NEVER ALLOW THE FREE FLOW OF AIR TO BE RESTRICTED.**
- Since the P-97 is a microprocessor-controlled device, it should be accorded the same system wiring precautions as any 'computer type' system. If microprocessor based systems in the lab require line surge protection for proper operation, then the same protection should be provided for the P-97.
- Only use Sutter Instrument Company replacement heating filaments.

### On handling micropipettes

Failure to comply with any of the following precautions may result in injury to the users of this device as well as those working in the general area near the device.

- The micropipettes created using this instrument are very sharp and relatively fragile. Contact with the pulled micropipette tips, therefore, should be avoided to prevent accidentally impaling yourself.
- Always dispose of micropipettes by placing them into a well-marked, spill-proof "sharps" container.
- Use only with glassware recommended by Sutter Instrument Company in the following section of this manual.



## GLASS CAPILLARY & HEATING FILAMENT SPECIFICATIONS

The P-97 micropipette puller is designed for use with aluminosilicate, borosilicate or other lower melting-point glass tubing or rod ranging from 1.0mm to 2.0mm in diameter. This instrument does not pull quartz glass. Examples of the specific types and sizes of glass that can be used with the P-97 are listed in the Sutter Instrument Company catalogue that was included with this instrument or can be viewed on Sutter Instrument Company's World Wide Web site at [www.sutter.com](http://www.sutter.com). Any glass with comparable technical specifications can be used with the P-97.

The type and size of glass that you choose may require a Heating Filament other than the one installed in your puller at the factory. Please refer to the Heating Filament section of this manual to determine the appropriate style and size of filament necessary for pulling the specific glass you would like to use. This instrument is designed to accommodate any of the Sutter Trough-type or Box-type filaments that are shown in the Sutter Catalogue. This selection of replacement filaments can also be viewed on Sutter Instrument Company's World Wide Web site at [www.sutter.com](http://www.sutter.com).

**ONLY USE SUTTER-SUPPLIED REPLACEMENT HEATING FILAMENTS IN THIS INSTRUMENT!** Instructions for replacing the Heating Filament can be found in the Maintenance section of this manual.

## UNPACKING

Make certain that you have received all of the following items in the P-97 shipping box:

- **P-97 micropipette puller**
- **Power cord**
- **Box of sample glass**
- **4 Spare heating filaments**
- **Warranty registration**
- **Catalog**

The Model P-97 is shipped to you in a custom box with foam inserts.. Please save shipping materials for future use. Should it ever be necessary to ship the puller to another location, the same packaging should be used to prevent damage to the instrument. Additional packing material may be purchased from Sutter Instrument Company.

**IMPORTANT: Improper packaging is a form of abuse and, as such, can be responsible for voiding the warranty where shipping damage is sustained as a result of such packing.**

## SETTING UP

### Line power (Mains)

The power cord provided with the P-97 connects to the Power Entry Module located on the back of the unit (see diagram below). This Module also includes the Line Fuse.

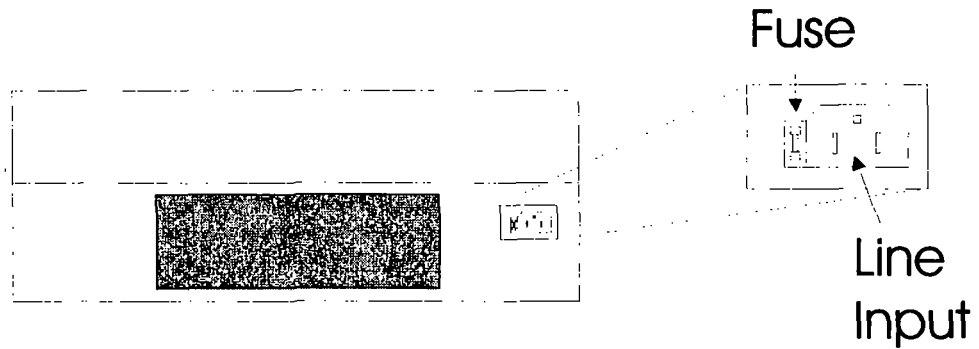

**Figure 1. P-97 Cabinet (rear view)**

Make certain that the Power Switch located on the left end of the P-97 cabinet is turned OFF.

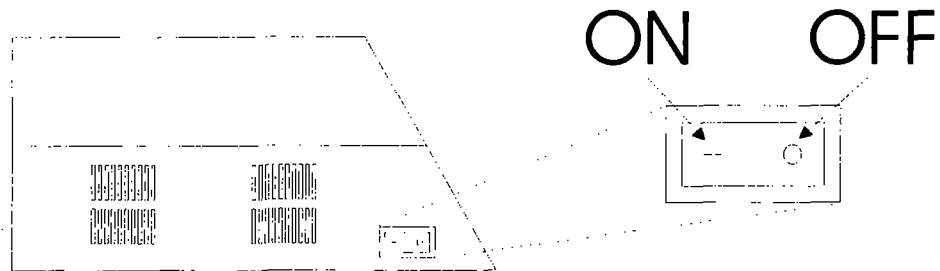

**Figure 2. P-97 Cabinet (end view, left)**

Plug the power cord provided with the P-97 into the Line Input socket on the Power Entry Module and then to a power source of the appropriate voltage and frequency.

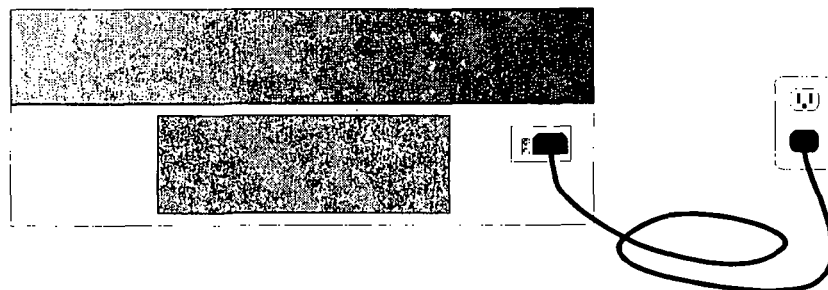
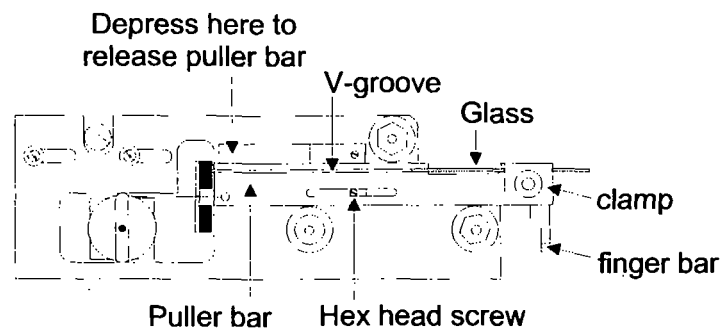

**Figure 3. Power Connection**

## FIRST TIME USE

While we realize that most new users of the P-97 are anxious to start pulling useable pipettes right away, we cannot over-state the importance of taking a few moments to review the manual in order to understand how the puller works. Many a heating filament has been destroyed with first use because the user did not understand the relationship between the programmable heat settings and the filament installed in the puller. If you absolutely must use the puller before reading through the manual, the following instructions are provided to help you get going and keep you from vaporizing your heating filament.

1. Make certain that the P-97 is plugged into the power outlet of the correct voltage and frequency.
2. Turn Power switch on left side of cabinet **ON**.
3. Press **< 0 >** followed by **< ENTR >** on the keypad to view Program 0. The cursor will be flashing on the **HEAT** parameter.
4. Inspect the parameter values displayed for Program 0. Program 0 should display the factory-installed values listed on the enclosed program sheet. If the values vary, jot down the values displayed and then re-enter the program sheet values. The program **HEAT** value should not exceed the listed **RAMP TEST** value by more than 10 units.
5. Load a piece of the supplied sample glass into puller as follows:



**Figure 4. Left Puller Bar**

- Loosen clamping knob.
- Place glass in V-groove in puller bar, slide it beyond clamp about 2 cm and tighten knob.
- Depress the spring stop on each puller bar to release them from their catch position.
- Pull both bars towards each other using the finger bars. Hold bars in position using the thumb and index finger from one hand. The hex head screw should be touching the end of the slot in both puller bars.
- Loosen both clamping knobs, carefully slide glass through the holes in the side of the heater chamber and into V-groove of opposite puller bar.
- Tighten down clamping knobs.

6. Press the < **PULL** > key on the keypad. The heating filament should turn on and the glass should separate in less than 10 seconds.
7. Loosen the clamping knobs and remove the pipettes from the puller bars.

Unless otherwise stated on your program sheet, Program 0 is factory pre-programmed to pull a micropipette (tip diameter less than 0.1 mm) from 1.0mm x 0.5mm borosilicate glass. Program 1 is factory pre-programmed to pull a patch type pipette with a tip diameter of about 2mm. To try the patch pipette program (#1):

1. Press **RESET** to exit Program 0
2. Press < 1 > followed by < **ENTR** > to enter into Program 1.
3. Repeat steps 4-7 above.

## FRONT PANEL

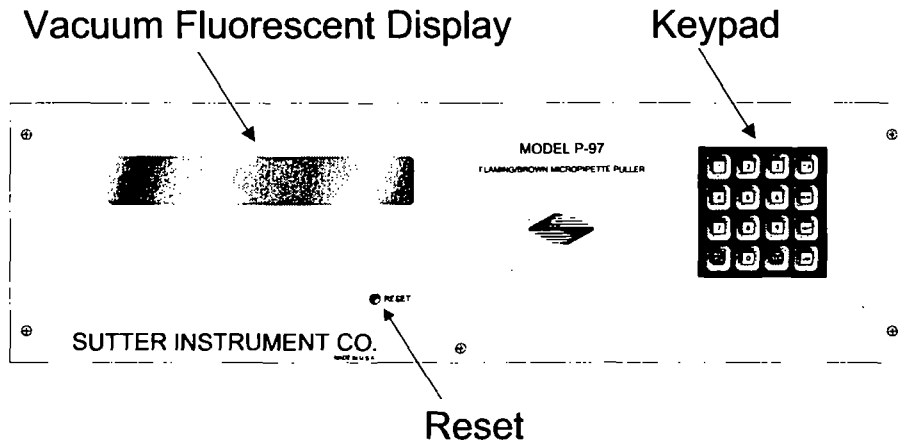

Figure 5. P-97 Front Panel

### Controls

<b>Vacuum Fluorescent Display</b>	Displays program parameters
<b>Reset</b>	Re-initializes the controller
<b>Keypad</b>	Used to program parameter values and execute programs
<b>0-9</b>	Used for choosing the desired program or control function, entering numeric values when programming and to make YES/NO (1/0) decisions
<b>CLR</b>	Used to delete programs or numeric values entered into those programs. This key is also used to access the RAMP TEST
<b>ENTR</b>	Used to enter new values
<b>NEXT</b>	Used to move to the next line in a program while editing
<b>LAST</b>	Used to move to the previous line in a program while editing
<b>PULL</b>	Initiates the execution of a program
<b>STOP</b>	Aborts the execution of a program

## Display

The P-97 has a two line vacuum fluorescent display for easy viewing from any angle. The following figure demonstrates what you will see after you have selected a program. A brief description of each parameter is provided below.

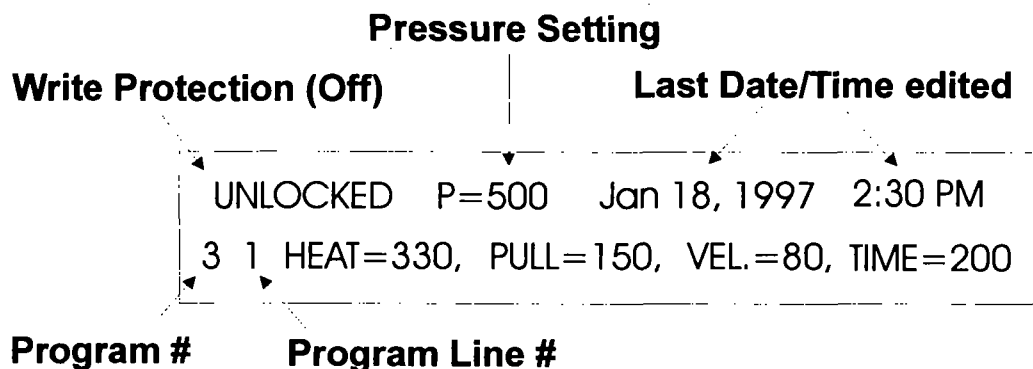

**Figure 6. Program Display**

**PROGRAM**  
(0-99)

A program consists of one or more cycles<sup>1</sup> which, when executed in sequence, will 'pull' the capillary glass inserted in the instrument. A program can be up to 8 cycles in length

**WRITE PROTECTION**  
(Locked/Unlocked)

Prevents program from being edited when in Locked mode.

**PRESSURE SETTING**  
(Range 0-999)

Reports the programmed value of the air pressure during the active cooling phase of the pull cycle.

**DATE/TIME**

Reports the date and time of the last program edit.

**HEAT**  
(Range 0-999)

HEAT controls the level of electrical current supplied to the filament. The HEAT required to melt a piece of glass is a function of the filament installed and the particular glass size and composition. It is important that the HEAT value be set relative to the Ramp Test value as discussed in the Operation Section. Generally, changes to HEAT will be made in steps of about 5 units since in most cases smaller changes will have little effect.

---

<sup>1</sup> A **CYCLE** consists of four programmable parameters; **HEAT, PULL, VELOCITY** and either **TIME** or **DELAY**. A **CYCLE** is equivalent to one line of program code. The sequence of events during execution of a cycle is described in the **PROGRAMS SECTION** of this manual.

**PULL**  
(Range 0-255)

This parameter controls the force of the hard pull. In general, the higher the PULL, the smaller the pipette tip diameter and the longer the taper. Useful changes in PULL strength are 10 units or more to see an effect.

**VELOCITY**  
(Range 0-255)

The velocity of the glass carriage system is measured as the glass softens and begins to pull apart under a constant load. The increasing velocity of the initial pull is determined by the viscosity of the glass, which in turn is a function of the glass temperature. The adjustable velocity allows for a selection of a precise glass temperature as the trip point for the hard pull. Useful values for velocity range from 10 to 150 with lower values being used for patch and injection pipettes and higher values for micropipettes. SEE THE PROGRAMS SECTION FOR A DISCUSSION OF THE SIGNIFICANCE OF VELOCITY=0.

**TIME**  
(Range 0-255)

TIME is one of two available modes of cooling and controls the length of time the cooling air is active. If VEL>0 then one unit of TIME represents 1/2ms. If VEL=0 then one unit of TIME represents 10ms. SEE THE PROGRAMS SECTION FOR A DISCUSSION OF THE SIGNIFICANCE OF TIME=0.

**DELAY**  
(Range 0-255)

DELAY is a cooling mode which controls the delay time between when the heat turns off and when the hard pull is activated. The gas is automatically turned on for 300ms. The higher the DELAY value, the cooler the glass will be when the hard pull is executed. Thus, increasing the DELAY results with decreased taper length and increased tip diameter. If VEL>0 then one unit of DELAY represents 1/2ms. If VEL=0 then one unit represents 10ms. SEE THE PROGRAMS SECTION FOR A DISCUSSION OF THE SIGNIFICANCE OF DELAY=0.



## MECHANICAL DESCRIPTION (puller anatomy)

### Some basic information

This section presents a basic mechanical description of the P-97, with particular emphasis on terminology. Knowing the names of the various parts greatly facilitates communication between the investigators and the manufacturer when discussing adjustments or service problems. In addition, various controls and adjustments on the top of the instrument are located and described. Those adjustments which are considered part of maintenance procedures are dealt with in the Maintenance Section of this manual.

### Air Cooling System

The Model P-97 supplies a blast of air to cool the filament area after the heating segment of a pull cycle. The components of the air cooling system are shown below.

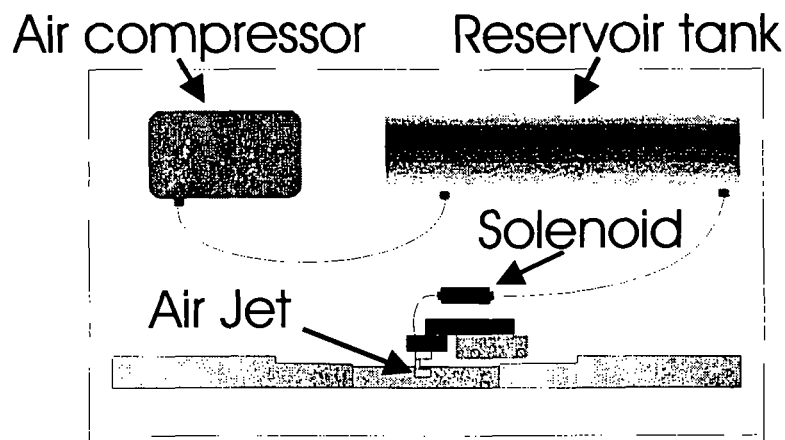

Figure 7. P-97 Base Plate (Top view, cover removed)

#### AIR COMPRESSOR (Figure 7)

Electronically controlled to pressurize the air reservoir tank

#### RESERVOIR TANK (Figure 7)

Low pressure vessel (filled with Drierite to remove moisture from the air flowing through the cylinder)

#### SOLENOID (Figure 7)

Regulates the flow of air from the air reservoir tank to the air under the filament

#### AIR JET (Figure 7)

Conducts air from the solenoid to the filament area. The air jet should be located 2 to 3 millimeters below the filament and centered on it. The screw that secures the air jet to the filament block can be loosened allowing the jet to move up and down.

## Heating Assembly

The HEATING ASSEMBLY comprises the FILAMENT, FILAMENT BLOCK ASSEMBLY and the CHAMBER. The FILAMENT BLOCK ASSEMBLY and the CHAMBER are discussed below. FILAMENTS are discussed in a separate section.

### CHAMBER (Figure 8)

The chamber encloses the filament block assembly to provide a controlled environment in which to pull the glass. Access holes in the side of the chamber allow the glass to be loaded into position. The chamber must be removed to access the heating filament. To remove, unscrew the thumb screw on the front plate of the chamber, remove the front plate and pull the chamber towards you.

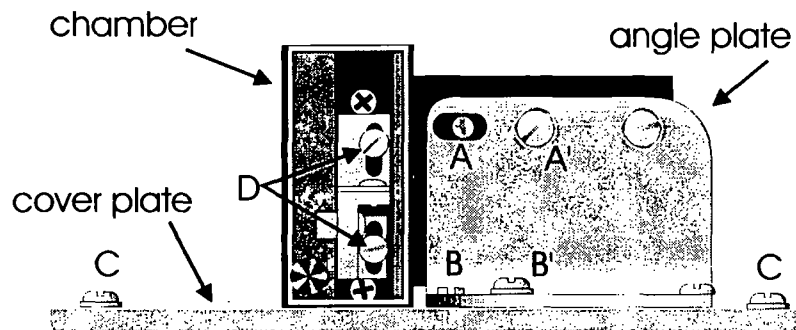

Figure 8. Filament Block Assembly

### FILAMENT BLOCK ASSEMBLY (Figure 8)

The filament block assembly is made up of several pieces of hard black nylon. Wires supplying current to the filament are attached to threaded 'posts'. This current is carried to the filament via the upper and lower HEATER JAWS. Note that these jaws are slotted and may be moved up and down by loosening the screws (D) that secure them to the front of the filament block assembly. If the jaws are moved, make sure that the securing screws have been tightened; otherwise poor current flow can result in insufficient HEAT to melt the glass.

### ANGLE PLATE (Figure 8)

The ANGLE PLATE secures the FILAMENT BLOCK ASSEMBLY to the COVER PLATE; it contains two important adjustments. Note the chrome-plated screws in slots at points A and B and the locking screws in slots at points A' and B'. The chrome-plated screws are 'eccentrics'; by rotating them with a screwdriver the FILAMENT BLOCK ASSEMBLY can be moved up and down (A) or forward and back (B) to adjust the position of the filament. Loosen the locking screw associated with each 'eccentric screw' before turning, and tighten after completing the adjustment.

### COVER PLATE (Figure 8)

The cover plate conceals the entry of the PULLING CABLES into the BASE of the instrument. It is attached to the top by two screws, in slots, at points labeled C. Loosening these screws allows the FILAMENT BLOCK/ANGLE PLATE assembly to move forward and back over large distances.

**NOTE:** The movements of the COVER PLATE and the JAWS constitute the 'coarse adjustments' of filament position, while the eccentric screws allow 'fine adjustments'.

### Upper Cable Pulley Assembly

This assembly guides the PULLING CABLES (T in Figure 9) from the PULLER BARS (G in Figure 9) to the centrally located (and concealed) LOWER CABLE PULLEY ASSEMBLY. Note that the UPPER CABLE PULLEY ASSEMBLY is attached to its panel by two screws, in slots (J' in Figure 9), and contains a large eccentric adjustment screw (J in Figure 9). This eccentric screw is used to adjust cable 'tension'. Its use is covered in the Maintenance Section.

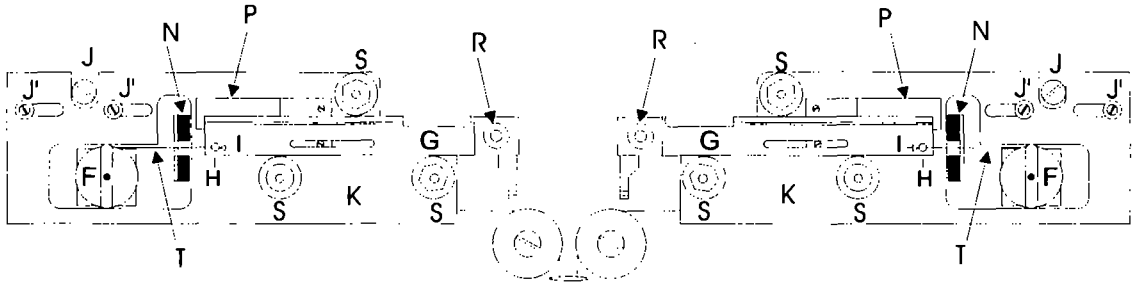

**Figure 9. Upper Cable Pulley Assembly**

### PANELS, LEFT AND RIGHT (K in Figure 9)

The panels are the angled surfaces that provide mountings for the PULLER BARS and their BEARINGS; the SPRING STOPS; the BUMPERS; and the UPPER CABLE PULLEY ASSEMBLIES. Except for minor differences in shape, the left and right PANELS are mirror images. Note the three socket-head cap screws that attach each PANEL to the top. These screws are used to align the PULLER BARS. Their adjustment, if necessary, is covered in the Maintenance Section.

### BUMPERS (N in Figure 9)

The BUMPER stops the motion of its associated PULLER BAR, and prevents impact forces from breaking pipettes.

### SPRING STOPS (P in Figure 9)

The SPRING STOPS are one-way catches that prevent pipette tip collision by catching the PULLER BARS as they rebound off the BUMPERS.

**PULLER BARS (G in Figure 9)**

This assembly consists of the puller bar, glass clamp, clamping knob and cable retaining screw. The puller bar is made of mild steel and coated with a controlled thickness of hard chrome. Glass is loaded into the groove near the tip of the puller bar and is held in position by tightening down the clamping knob (**R**). The cable retaining screw (**H**) holds the cable in a shallow groove (**I**) at the end of the puller bar, and forms the 'resistance' against which the cable ends pull.

**V-BEARINGS (S in Figure 9)**

These bearings are the guides for PULLER BAR motion. They are made of stainless steel and should **NEVER** be oiled (see Maintenance Section). Note that these bearings are mounted on stainless steel bushings, one of which is round with the other two being hexagonal. The hexagonal bushings are used to adjust position and ease of travel of the PULLER BARS (see Maintenance Section).

**PULL CABLE (T in Figure 9)**

This cable transmits the pulling force of the solenoid to the PULLER BARS via the UPPER (**F**) AND LOWER PULLEY ASSEMBLIES. It is made of flexible metal with a nylon coating. Never pinch or distort the cable. The cable is terminated with crimped-on clamps or 'swages'.

**Cabinet****BASEPLATE**

The metal plate on which the mechanical assemblies are mounted.

**BASE**

The BASE includes the cabinet to which the BASEPLATE is mounted as well as the transformers and the circuit board contained within.

**Electronics**

The P-97 micropipette puller is controlled by a Z-80 microprocessor. Three digital-to-analog (D-A) converters control the HEAT, PULL and VELOCITY values. The HEAT power supply is a precision constant current switching unit which will vary less than 10 milliamperes with a plus or minus 10% change in the a.c. line current. The PULL supply is a constant current d.c. power supply. The velocity trip point is set by a D-A converter. The output of the velocity transducer is compared to the output of the velocity D-A to determine when the trip velocity is reached.

## PROGRAMS

### Program structure

The ultimate size and shape of a micropipette made using the P-97 is determined by the parameter values that are programmed by the user. 100 separate programs can be saved for future use. Each program is structured as follows:

<b>PROGRAM</b>	Consists of one or more <b>CYCLES</b> which, when executed in sequence, will 'pull' the capillary glass inserted in the instrument. A program can be up to 8 cycles in length.
<b>CYCLE</b>	A <b>CYCLE</b> consists of four programmable parameters; <b>HEAT</b> , <b>PULL</b> , <b>VELOCITY</b> and either <b>TIME</b> or <b>DELAY</b> . A <b>CYCLE</b> is equivalent to one line of <b>PROGRAM</b> code.

### Cycle parameters

Each of the four programmable parameters in a **CYCLE** are defined below:

<b>HEAT</b>	<b>HEAT</b> controls the level of electrical current supplied to the filament. The <b>HEAT</b> required to melt a piece of glass is a function of the filament installed and the particular glass size and composition. It is important that the <b>HEAT</b> value be set relative to the Ramp Test value as discussed in the Operation Section. Generally, changes to <b>HEAT</b> will be made in steps of about 5 units since in most cases smaller changes will have little effect.
<b>PULL</b> (Range 0-255)	This parameter controls the force of the hard pull. In general, the higher the pull, the smaller the pipette tip diameter and the longer the taper. Useful changes in <b>PULL</b> strength are 10 units or more to see an effect.

**VELOCITY**  
(Range 0-255)

The VELOCITY of the glass carriage system is measured as the glass softens and begins to pull apart under a constant load. The increasing velocity of the initial pull is determined by the viscosity of the glass, which in turn is a function of the glass temperature. The adjustable velocity allows for a selection of a precise glass temperature as the trip point for the hard pull. Useful values for velocity range from 10 to 150 with lower values being used for patch and injection pipettes and higher values for micropipettes.

**Special Condition: VELOCITY = 0**

If VEL=0 and PULL=0, the HEAT will be on for the duration of the TIME programmed (1 unit equals 10ms). This feature allows you to use the puller in a FIRE POLISH MODE.

**TIME**  
(Range 0-255)

Controls the length of time the cooling air is active. This parameter is one of two available modes of cooling. If VEL>0 then one unit of TIME represents 1/2ms. If VEL=0 then one unit of TIME represents 10ms.

**Special Condition: TIME = 0**

The air solenoid is disabled when TIME=0 (no active cooling). This allows the pulling of special pipette shapes. Most often used to pull long tube-like shapes such as those used for microperfusion.

**DELAY**  
(Range 0-255)

A cooling mode which controls the delay time between when the HEAT turns off and when the hard PULL is activated. The air is automatically turned on for 300ms. The higher the DELAY value, the cooler the glass will be when the hard PULL is executed. Thus, increasing the DELAY results in decreased taper length and increased tip diameter. If VEL>0 then one unit of DELAY represents 1/2ms. If VEL=0 then one unit represents 10ms.

**Special Condition: DELAY = 0**

The air solenoid is disabled when DELAY = 0 (no active cooling). This allows the pulling of special pipette shapes. Most often used to pull long tube-like shapes such as those used for microinjection or microperfusion.

### Pull cycle

A typical PULL CYCLE in a PROGRAM is described below:

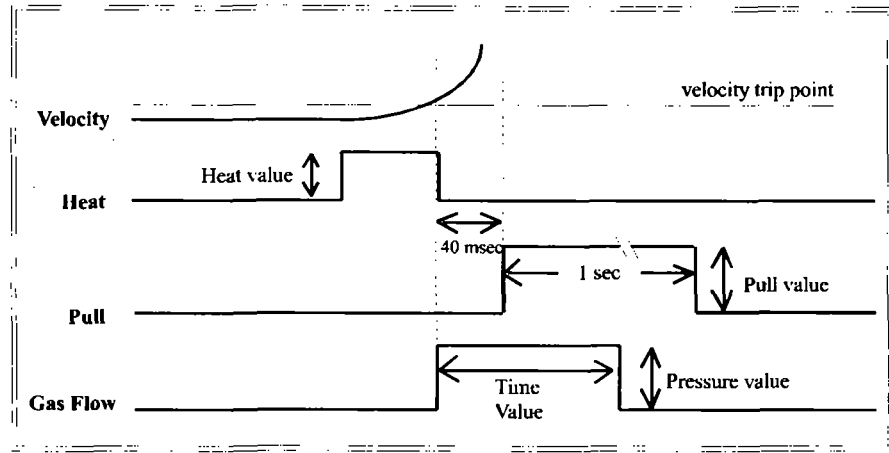

**Figure 10. Pull Cycle when TIME > 0**

1. The heat turns on.
2. The glass heats up and a weak pull draws the glass out until it reaches the programmed velocity.
3. When the programmed velocity has been reached, the heat turns off and the air is turned on.
4. If TIME is >0 The hard pull (if any) is executed after a 40ms delay and the air is activated for the specified TIME (Figure 10).

If DELAY is >0 The air is activated for 300ms and the hard pull is activated after the specified DELAY (Figure 11).

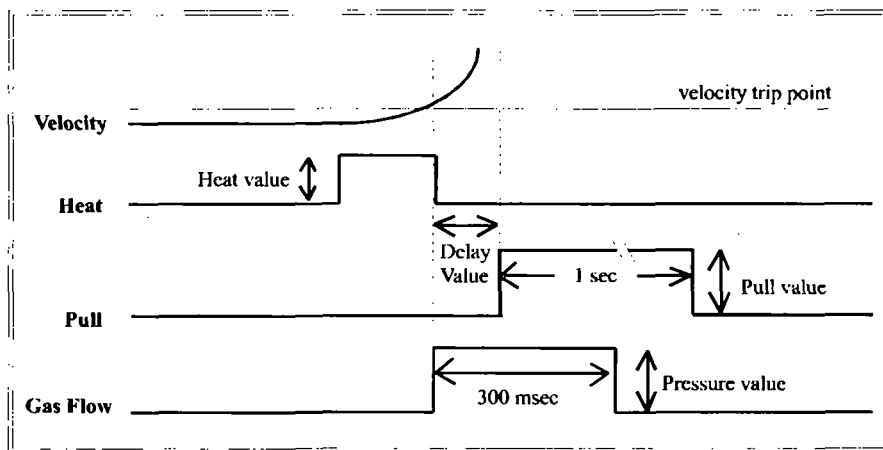

**Figure 11. Pull Cycle when DELAY > 0**

## Default Configuration

Unless special programming or setup was requested at the time of purchase, the puller was setup and shipped with the following standard factory configuration:

Heating Filament Installed	3mm trough (catalog #FT330B)
Glass used to program puller (sample sent with puller)	1.0mm O.D. x 0.5mm I.D. borosilicate, without internal filament (catalog #B100-50-10)
Factory installed programs (see enclosed program sheet)	0 -Micropipette (tip diameter less than 0.1 $\mu\text{m}$ ) 1 -Patch type pipette

**Table 1. Standard Factory Configuration**

In describing the operation of the puller, the above configuration is assumed. If the configuration of your puller differs, the operating instructions still apply but references to specific program settings may not be accurate. Inappropriate settings will, in general, only affect your ability to control the geometry of the glass micropipette you are trying to fabricate. However, **the heating filament can be destroyed by an excessive value for the HEAT parameter**. We recommend you refrain from executing a program until you have read through this section of the manual and have run the Ramp Test described herein.

## Selecting a program

< 0 to 99 >

After applying power to the instrument, a "power on" reset will occur and the display will appear as follows:

WHICH PROGRAM DO YOU WANT? (0-99)

COPYRIGHT SUTTER INSTRUMENT CORP. 1992

**Figure 12. Power On Display**

The P-97 has the capacity to store 100 programs (0 - 99). On the keypad, press < 0 > followed by < ENTR > (factory installed micropipette program) or the number of another program you wish to execute. The display will appear as shown below in **Figure 13** (numerical values may vary). Please refer to the FRONT PANEL chapter and the beginning of this chapter for a full description of the PARAMETERS shown.



```

UNLOCKED P=500 Jan 18, 1997 2:30 PM
3 1 HEAT=330, PULL=150, VEL.=80, TIME=200

```

**Figure 13. P-97 Program Display**

To select a different program, Press **< RESET >** to bring up the sign-on prompt then press the number of the desired program (0 to 99) followed by **< ENTR >**.

### Viewing a program

**< NEXT > / < LAST >**

The front panel display limits you to viewing only two adjacent lines of a PROGRAM at one time. When you first select a PROGRAM the display above will appear. The top line of every program is a header line which displays the PRESSURE setting, the WRITE PROTECT STATUS and the LAST EDIT DATE. The second line of the display is Line 1 of program.

To view additional lines of the program **press the < NEXT > key**

To scroll to previous lines **press the < LAST > key.**

### Clearing a program from memory

**< CLR >**

To clear the values of a particular program from memory you can utilize the CLEAR function.

Pressing the **< CLR >** key gives you the following message:

```

DO YOU WISH TO CLEAR ALL VALUES FROM THE
PRESENT CYCLE TO THE END? NO=0 YES=1

```

**Figure 14. Clear Program Display**

Entering **< 1 >** will clear the PROGRAM from the line the cursor is on to the end of the PROGRAM. If the cursor is on Line 1, the entire program will be cleared from memory. If the cursor is on Line 2, Line 1 will be preserved, and lines 2-8 will be cleared.

## Editing a program

Select a program number (e.g. 10). If there are already values entered, make sure that this program was not entered by another user of the puller. Unused program areas are usually cleared before a puller is shipped, but occasionally test program values are inadvertently left in memory. We recommend that unused programs be cleared before proceeding.

### Entering a new program

After selecting or clearing a program area, the cursor will be blinking at the HEAT parameter on Line 1. To familiarize yourself with program entry, enter the following sample micropipette program:

HEAT	PULL	VELOCITY	TIME
300	150	100	150

Press the series of numbers < 300 > to enter the HEAT value of 300. The cursor will automatically tab over to the PULL parameter.

Enter < 150 > for PULL. The cursor will tab over to the VELOCITY parameter.

Enter < 90 > for VELOCITY. The cursor will remain there, blinking. **Note that when less than three digits are entered, the cursor will not automatically tab to the next field.** You must press < ENTR > to enter the value and tab to the next field.

Enter < 150 > for TIME. The cursor will tab to the next field which is HEAT in Line 2.

### Editing an existing program

To edit the value of a parameter(s) in a particular line, the cursor must be blinking in the field you want to edit. If necessary, press < NEXT > or < LAST > to scroll to the line you want to change. Press < ENTR > to tab the cursor to the field you want to change, and enter the new value. In our example above, to change the value of VELOCITY in Line 1 you first press < LAST > to scroll up to Line 1. Then press < ENTR > two times to tab over to the VELOCITY field. Note that the values for HEAT and PULL remain unchanged. Enter a new value (e.g. 90); if the value is two digits you must press < ENTR > to enter the value. The cursor will be positioned on Line 1 in the TIME field. To move to Line 2, press < ENTR > to "tab" over to the HEAT field in Line 2.

The program values above are only given to demonstrate data entry procedures. Useful program values to pull the pipette that you want will be discussed in the next chapter. In general, inappropriate settings will only affect your ability to control the geometry of the glass micropipette you are trying to fabricate. However, **the heating element can be destroyed by an excessive value for the HEAT parameter. Do not use HEAT settings greater than those found in programs 0 and 1 until you have run the RAMP TEST** described in the next section.

## SOFTWARE CONTROL FUNCTIONS

The P-97 has several unique software CONTROL FUNCTIONS that allow you to, among other things, run SELF-TEST procedures, set up some of the PULL CONDITIONS and WRITE-PROTECT your program. These CONTROL FUNCTIONS are accessed through the < CLR > key. Pressing < CLR > gives you the following message:

DO YOU WISH TO CLEAR ALL VALUES FROM THE  
PRESENT CYCLE TO THE END? NO=0 YES=1

**Figure 15. Access to Control Functions**

Entering < 0 > will provide you with access to the following P-97 CONTROL FUNCTIONS:

Function #	Function Name	Description
1	RAMP TEST	Run the Ramp Test
2	CHANGE AIR PRESSURE	Set the air pressure for a program
3	AIR MODE	Select the active cooling mode
4	AIR TIME AT START OF PULL	De-humidify the heating chamber prior to pulling
5	AIR TIME AT END OF PULL	Purge chamber at end of pull
6	RESET TIME AND DATE	Set the clock
7	WRITE-PROTECT THE PROGRAM	Lock or unlock the write-protection
8	MEMORY TEST	Test the integrity of the RAM

**Table 2. Control Functions**

The 8 CONTROL FUNCTIONS will scroll along the bottom line of the display. Select the desired CONTROL FUNCTION by pressing the corresponding numeric key. Each CONTROL FUNCTION is more completely described below.

## RAMP TEST < 1 >

The HEAT value required to melt your glass is based on the characteristics of the heating filament that is installed and the glass you are using. The RAMP TEST allows you to systematically establish or adjust program HEAT values as a function of the filament/glass combination. This test should be run when using the puller for the first time, before writing or editing a program, whenever you change glass or whenever you change the heating filament.

To run a RAMP TEST:

1. Go into any program. For example, Press <1> and then <ENTR> to select Program 1
2. Press <CLR>
3. Press <0> to not clear parameteres
4. Select <1> for RAMP TEST
5. Install glass and press <PULL>

When executed, events in the RAMP TEST take place as follows:

1. The puller increments the HEAT at the rate of 650 milliamps per second.
2. The puller bars begin to move apart as the HEAT output begins to soften the glass.
3. The HEAT is turned off when a certain velocity (the value of which is stored in ROM) is achieved.
4. The RAMP TEST value shown on the display is the HEAT value that was required to reach the factory-set RAMP TEST velocity.

To interrupt the RAMP TEST or reset the display press RESET.

### Recommendations

For Trough filaments:     Maximum program HEAT value(s) = Ramp value + 35 units.  
                                   Recommended starting value = Ramp + 15 units.

For Box filaments:         Maximum Program HEAT value(s) = Ramp value + 30 units.  
                                   Recommended starting value = Ramp value.

Additional guidelines for setting program HEAT values relative to RAMP TEST values are given in the Programming Section of this manual. **HEAT settings over RAMP +35 can damage or burn out the filament.**

**CHANGE AIR PRESSURE < 2 >**

This control sets the pressure generated by the air compressor during the active cooling phase of the pull cycle. Each time a pull is started the air pressure is corrected before the filament turns on. A value must be entered each time this function is accessed. Changes of less than 10 units will not be noticeable. Air pressure is reported on the program header line.

**Range**                                 **1 to 999**  
**Default**                                **500**

**Recommendations**

For thick walled glass                500  
 For thin walled glass                 300

**AIR MODE < 3 >**

Select between one of two modes of cooling during the active cooling phase of the pull cycle. The mode is reported in the fourth field of each program line.

**TIME MODE**                    Controls the length of time the gas is on during the cooling phase. The onset of the hard pull is set at 40ms. One unit of TIME is equal to 1/2 millisecond [ e.g., at a setting of 150 the cooling air will be on for 75ms].

**DELAY MODE**                Controls the onset of the hard pull. The gas is turned on for 300 ms during the cooling phase. One unit of DELAY is equal to 1/2 millisecond [e.g. a setting of 80 will delay the onset of the hard pull by 40 ms].

**Default**                        **TIME MODE**

**Recommendations**

Use the TIME MODE for:

patch pipette programs  
 glass <1.2mm O.D.  
 transfer of model P-87 puller programs to P-97

Use the DELAY MODE for:

single cycle programs  
 glass >1.2mm O.D.  
 transfer of model P80-PC puller programs to P-97.

**AIR TIME AT START OF PULL < 4 >**

Controls the length of time the humidity control chamber is purged with dehumidified air prior to execution of the pull sequence. The intent of the control is to minimize and stabilize the chamber humidity during the pull sequence. Units are in seconds.

**Range**                    **1 to 255 seconds**

**Default**                **5 seconds**

**Recommendations**

For humid                20 to 30 seconds  
environments

**AIR TIME AT END OF PULL < 5 >**

Controls the length of time the chamber is cooled after completion of the pull and the length of time the end of pull information is displayed. Units are in seconds. The time you enter is actually an offset added to an automatic 3 second chamber cooling cycle [e.g. A setting of 5 would result with 8 seconds of chamber cooling].

**Range**                    **0 to 255 seconds**

**Default**                **5 seconds**

**Recommendations**

for single cycle programs    5 seconds

for multicycle programs    25 seconds  
(to allow additional cooling  
of the heating clamp assembly).

**RESET TIME AND DATE < 6 >**

This function allows you to set the system clock. The clock is used to establish the date and time of the last program edit as displayed on the program header line.

**WRITE-PROTECT THE PROGRAM < 7 >**

Activate (lock) or inactivate (unlock) the WRITE PROTECTION mode. Unlocked mode ( 0 ) allows program to be edited. Locked mode ( 1 ) prevents program from being edited. The write-protect status is reported on the program header line.

**Default**                    **Unlocked**

**MEMORY TEST < 8 >**

Performs a non-destructive test of the RAM. Press RESET to reset the system after performing this test.

## PULLING PIPETTES

### Procedures

Prior to pulling a pipette for the first time, it is important to establish what HEAT value is appropriate to melt your glass. Before executing a program for the first time, **run the RAMP TEST** as previously described, and note the Ramp value reported. The HEAT settings in the factory-installed programs are typically set at Ramp value plus 15 units. If your Ramp test value differs from the factory Ramp value, adjust the HEAT in your programs to your Ramp value plus 15 units.

Once you have adjusted the HEAT value relative to the Ramp value, pulling a pipette is very straightforward. Try executing the factory installed programs with the sample glass to acquaint yourself with the pulling process.

- 1) Load the glass into the puller as described previously in the **FIRST TIME USE** chapter.
- 2) Press < 0 > followed by < ENTR > on the keypad to view Program 0.
- 3) Inspect the parameter values displayed for Program 0. Program 0 should display the factory-installed values listed on the enclosed program sheet. Adjust the HEAT setting to your Ramp value plus 15 units.
- 4) Press the < PULL > key on the keypad. The heating filament will turn on and the glass should separate within 10 seconds. The display will then report the number of heating cycles and the total time that the heat was on, similar to the following:

```

THE PROGRAM LOOPED 01 TIMES. THE LAST
LINE USED WAS 01. HEAT ON SEC. = 6.05

```

**Figure 16. Pull Cycle Report**

- 5) Loosen the clamping knobs and remove the pipettes from the puller bars.

Unless otherwise stated on your program sheet, Program 0 is factory pre-programmed to pull a micropipette (tip diameter less than 0.1 mm) from 1.0mm x 0.5 mm borosilicate glass. It will pull the pipette in one heating cycle or 'loop'. The time reported is very useful for developing programs and will be discussed in the Parameter Adjustment section of this manual.

A unique feature of the P-97 is its capability to loop through a program. This is demonstrated with the multicycle Program 1, which is factory pre-programmed to pull a patch type pipette with a tip diameter of about 2mm. Press RESET to exit Program 0, and then press < 1 > followed by < ENTR > to enter into Program 1. The display for Program 1 should read similar to the following:

```

UNLOCKED,    P = 500,    JAN 18 1993  2:35 PM
1 1 HEAT = 285, PULL = 0, VEL. = 50  TIME = 150

```

**Figure 17. Sample Program**

Adjust the HEAT in the program to Ramp value plus 15 units. Load glass into the puller and press < PULL >. The heating filament should cycle on and off repeatedly. When the pull is complete, the display should read similar to the following:

```

THE PROGRAM LOOPED 04 TIMES. THE LAST
LINE USED WAS 01. HEAT ON SEC. = 14.7

```

**Figure 18. Pull Cycle Report (multiple-loops)**

After the heat turns on in line 01, the glass heats up and draws apart until it reaches a VELOCITY of 50, at which point the heat turns off and the cooling air turns on. The puller is "aware" of the fact that the glass has not separated yet, and will go back to line 01 of the program and try again; in effect it begins 'looping'. It will continue to do so until the glass separates. This looping capability is particularly useful for fabricating patch pipettes, which require multiple heating cycles to form the characteristic stubby geometry.

## Notes on Program Operation

There is always the possibility that the puller will be given a set of values which 'stall' its operation. An example might be where the HEAT value has not been set high enough to melt the glass, thus the glass can not be pulled and no VELOCITY can be achieved. If it appears that a situation of this type has arisen, press the STOP key. This action aborts program execution and allows editing to take place.

All programs entered into memory (maximum of 100) remain there even after the power is turned off or the RESET switch is toggled. A special memory 'chip' that carries its own battery back-up will retain stored information for as long as ten years without power being applied to the instrument. Miracle that this is, it is strongly suggested that you keep a written record of your programs in case of unexpected difficulties.



## PARAMETER ADJUSTMENT

### General Information

Micropipette and microinjection needle programs are sufficiently different from patch pipette programs that the following information on parameter adjustments has been divided into three sections: **Micropipette/microinjection needle fabrication**, **Patch pipette fabrication** and **Technical Tips**. Even if your research only requires one type of pipette, we recommend that you read through all three sections for full appreciation of the capabilities of the puller. Please note that the programs referred to in the following text are not necessarily meant to pull functional pipettes, but are intended as an exercise to help develop an understanding of the programming process. Unless otherwise stated, parameter adjustments assume that the puller is in the **TIME** mode of active cooling (see Software Control Functions).

### Micropipette/Microinjection Needle Fabrication

Consider the following programs using a 3mm-trough filament:

Micropipette Program using 1.0mm x 0.5mm borosilicate tubing

HEAT	PULL	VELOCITY	TIME	PRESSURE
Ramp + 15	150	100	150	500

Microinjection Needle Program using 1.0mm x 0.75mm borosilicate tubing

HEAT	PULL	VELOCITY	TIME	PRESSURE
Ramp + 15	60	80	200	300

#### HEAT

The HEAT setting will affect the length and tip size of the pipette. Generally speaking, higher HEAT settings tend to give longer and finer tips. For trough filaments, the recommended starting HEAT value is the ramp test value plus 15 units. For box filaments the recommended starting HEAT value is the ramp test value. The program listed above will typically have heat on for 5 to 8 seconds after the < PULL > key is pressed. If the time is longer than eight seconds, and you are trying to pull a fine micropipette, increase the HEAT in 5 unit increments until the pull takes place in less than eight seconds. If the pull occurs in less than three seconds, decrease the HEAT until the pull takes place in 4 to 8 seconds. For the best micropipette reproducibility with the finest tips, you should select a HEAT value that melts the glass in 5 to 6 seconds. For microinjection needles you should select a HEAT value that melts the glass in about 7 seconds or longer.

#### PULL STRENGTH

Low values of PULL strength in the range of 40-75 will give larger tips appropriate for injection needles, while settings between 120-250 give smaller tips appropriate for micropipettes. The PULL strength can be set to any value desired with no danger of damaging the instrument.

## **VELOCITY (trip point)**

The VELOCITY value determines the point at which the heat is turned off. VELOCITY reflects the speed at which the two carrier bars are moving during the weak pull. The lower the VELOCITY value the slower the speed of the bars when the trip point occurs. Although VELOCITY can safely be set to any value from 1-255, all values over a maximal trip point (about 150) will produce equivalent results. This can be understood by referring to **Figure 10**. As the pull progresses, the speed of the carrier bars, as measured by the velocity transducer, reaches a point where further increases in the VELOCITY trip point will not change the time point at which the heat is turned off. VELOCITY is typically set between 80 to 120 for micropipettes or 50-80 for microinjection needles.

In a multiple cycle program, it is possible for the glass to separate before the trip velocity is attained. Thus, the glass is subjected to heating as it separates. Such an occurrence can lead to difficulties in forming tips as well as lack of reproducibility. If you are using a one-line, looping program, try decreasing the VELOCITY a few units at a time. If your program is a multi-line program, decrease the VELOCITY in the next to last line of the program. Decreasing the VELOCITY will increase the amount of glass left in the last cycle of the program, thus allowing the glass to attain the trip velocity before separating.

## **TIME**

The TIME parameter controls the length of time the cooling air is active (one unit of TIME is equivalent to 1/2msec). In order to produce effective cooling, the air must be supplied to the filament and glass during the time the tip is being formed. In order to guarantee that cooling occurs in this time frame, the start of the hard pull is begun after a fixed delay of 40msec from the termination of the heating cycle and the activation of active cooling. In most applications, the hard pull lasts several tens of milliseconds. Because of this fact, increasing cooling TIME values beyond a certain range (typically between 150 to 200) will have no effect. Values of TIME shorter than this same range will cool the glass less as the tip is being formed and lead to a longer taper. However, once TIME values become too short (values in the range 110 to 130) cooling becomes ineffective. The glass will not form a tip and instead forms a wispy fiber. The very finest tips for a given PULL and HEAT will be formed at an air setting of about 5 units higher than the lowest TIME value that forms a tip. Because of this quite narrow working range of usable TIME values for making micropipettes, it is not recommended to vary cooling, and therefore electrode tip length, by adjusting TIME. Adjusting the cooling air pressure, or switching to the DELAY mode of active cooling are both more effective means of controlling tip length (see below).

## **DELAY MODE OF ACTIVE COOLING**

In TIME mode, especially when using larger and or thicker wall glass, active cooling may not be sufficient to produce short pipette tapers. This may even be true at increased PRESSURE settings (i.e. >500). In this case, it is recommended that the DELAY mode of active cooling be used. The method for changing to the DELAY mode are described under "Software Control Functions" and a brief description of the two modes of cooling is given in "Programs."

After switching to DELAY mode, one then has direct control over the delay between the turn off of the heating filament and the initiation of the hard pull. Because the cooling air is turned on when the filament is turned off (see **Figure 11**), increasing DELAY profoundly increases glass cooling before and during the hard pull.

With a range of control over the degree of pipette cooling one can control of the rapidity of pipette taper. Longer DELAY values increase cooling and form a pipette with a more rapid taper (shorter shank) while shorter DELAY values decrease cooling and form a pipette with a more gradual taper (longer shank). Fortunately, cooling induced changes in pipette taper generally occur with little effect on tip size. This is quite valuable as the resistance of pipettes is a strong function of the length of the taper. By making a pipette with a sharper taper one can often decrease pipette resistance significantly without changing the size of the pipette tip. Furthermore, the ability to control tip length is invaluable for experiments where long tips are necessary for penetration into deep tissues or where short stiff tips are necessary for adequate beveling.

Minimum and maximum useable values of DELAY can be expected; their exact values are dependent on glass thickness and diameter. If DELAY is too short the glass will not cool sufficiently to form a tip and a long wispy fiber of glass will be formed. This minimum DELAY value is typically 80 (40ms of delay). At some maximal value of DELAY the glass may be cooled too much to separate during the hard pull. Under these conditions, the puller will typically execute multiple cycles in order to separate the glass and the glass may break at a large tip diameter. Maximum usable values of DELAY will be dependent on glass dimensions but are expected to be near 200 (100ms of delay).

### **PRESSURE ADJUSTMENT**

The pressure setting controls the pressure of the cooling air delivered to the filament. The higher the pressure, the shorter the pipette taper will be. Because thin walled glass cools more rapidly than thick walled glass, the recommended values are £ 300 for thin walled tubing and 500 for thick walled or standard walled tubing. By varying PRESSURE around these values, the user can control pipette tip length over a moderate range.

Note that increasing the pressure value to some higher number results in an immediate change in the pressure. A decrease in the pressure value will result in a pressure change at the time of the next pull. This delay in pressure change occurs because the system must first be purged of the air that is pressurized at the higher level. This will only occur prior to the execution of a program. Each time the < PULL > key is pressed the air solenoid is opened and air flows through the air jet until the pressure drops below the set value. The solenoid then closes and the compressor will pump until the correct pressure is attained. This pressurization routine is meant to fully cool the filament and assure that the pressure is precisely set.

### **FILAMENT WIDTH**

Further control over pipette tip length can be accomplished by varying filament width. Longer tips can be formed by using wider filaments and conversely shorter tips can be formed by using narrower filaments.

## Patch Pipette Fabrication

Pipettes used for the electrophysiological recording technique of "patch clamping" are characterized by a short, stubby shank and relatively large diameter tips (> 0.7 mm). Programs that can fabricate a pipette with these characteristics generally differ from programs for micropipettes in three ways:

**The trip velocity is lower.**

**The PULL strength is typically turned off.**

**More than one heating cycle is used.**

The P-97 can be used very effectively for this type of processing. The following general information will familiarize you with the effect of adjusting each of the pull cycle parameters in a typical patch pipette program. Following this general information are step-by-step instructions intended to help you establish a stable program to pull patch type pipettes and should be followed in the order described.

Consider the following sample patch program for 1.5 mm O.D. by 1.1 mm I.D. borosilicate glass using a 2.5mm box filament:

HEAT	PULL	VELOCITY	TIME	PRESSURE
Ramp	0	40	250	500

A program sequentially executes each line of code and then loops back to the start and begins again until the glass separates. A single line program such as this may execute 2 to 4 times before the glass separates.

### HEAT

The actual HEAT value used should be sufficiently high to allow the glass to melt in the first cycle in 5 to 15 seconds. Using a higher HEAT that melts the glass in less than 5 seconds will cause no problem in the first heating cycle, but may heat the glass so much in subsequent heating cycles, that the air cooling will be less effective.

### PULL STRENGTH

There is a constant gravitational pull on the carrier bars that can be felt when loading the glass. This pull is usually adequate to form fairly small tipped pipettes (0.5 mm). Eliminating the hard pull from the program (PULL=0) is recommended for most pipettes. If smaller tips are required, a moderate PULL (25-50) may be used in the last line of a multi-line program (see below).

### VELOCITY (trip point)

VELOCITY determines the point at which the heat is turned off. If the value is too high, the glass will separate after the first or second heat cycle. As the VELOCITY is decreased, the amount of glass drawn-out in a given cycle will also decrease, and more cycles will be required to form a tip. The greater the number of cycles, the larger the tip and the shorter the taper. However, too many cycles can lead to variability. Generally speaking, it is advisable to keep the number of heating cycles to 5 or less.

## TIME

For patch pipette programs, it is advisable to keep the TIME between 200 and 250 to maximize the cooling of the glass. DELAY mode of active cooling is not used in patch pipette fabrication.

By contrast to micropipette pulling (see above), the TIME settings in the upper range of available values can have a pronounced effect on glass cooling. This additional cooling is effective due to the lack of a hard pull and the multiple cycle nature of the pulling process for patch pipettes.

## PRESSURE

As with micropipette fabrication, the recommended pressure setting when using thick walled glass is 500 or greater. For thin walled glass the recommended setting is 300.

Note that increasing the pressure value to some higher number results in an immediate change in the pressure. A decrease in the pressure value will result in a pressure change at the time of the next pull. This delay in pressure change occurs because the system must first be purged of the air that is pressurized at the higher level. This will only occur prior to the execution of a program. Each time the < PULL > key is pressed the air solenoid is opened and air flows through the air jet until the pressure drops below the set value. The solenoid then closes and the compressor will pump until the correct pressure is attained. This pressurization routine is meant to fully cool the filament and assure that the pressure is precisely set.

### Step-by-step patch pipette programming

Run a Ramp Test with the glass you intend to use for your particular application. Refer to the manual if you need to review the Ramp Test procedure. When you know the Ramp value (R), use it in the following program.

1. Program one line of code as follows:

	HEAT	PULL	VELOCITY	TIME
for trough filament:	R+15	0	*50	150
for box filament:	R	0	*30	250

**PRESSURE** should be set to 500 for thick walled glass and 300 for thin walled glass.

\*The **VELOCITY** value will need to be manipulated.

2. Insert your glass and execute the above program. The program should "loop" a multiple number of times (i.e. the same line will be repeatedly executed). The display will report the number of loops at the end of the pull sequence. This "looping" is the key to forming patch pipettes. For thin walled glass, 3 to 4 loops are typically all that is required. For thick walled glass, 3 to 5 loops are typically required.
3. Increase the **VELOCITY** in 5 unit increments and pull a pipette after each adjustment. Note the change in the number of loops and note the geometry of the pipette (viewed with microscope). As the **VELOCITY increases**, the number of loops **decreases**.

4. Repeat step (3) only this time decrease the VELOCITY. As the VELOCITY **decreases**, the number of loops **increases**.
5. By adjusting the VELOCITY as described, establish the number of loops required to approximately form a pipette with the characteristics you desire. Set the VELOCITY value in your program to the number that falls midway between the values required to loop one more and one less times than the desired number. For example: let's say that when you are experimenting with VELOCITY values, you find that when the glass separates after 3 loops, the resulting pipette looks pretty reasonable. Let Y be equal to the VELOCITY value that results with the glass separating after 4 loops. Let Z be equal to the VELOCITY value that results with the glass separating after 2 loops. Set your program VELOCITY, to a value midway between Y and Z. This value will be a very stable VELOCITY value and will provide you with the most reproducible results.
6. The one line program just established may be sufficient for your application. However, changes made in a one-line program are amplified throughout the program and can produce gross changes in the pipette. If you need to make fine adjustments to the pipette geometry, then you should use a multi-line program. The multi-line program is based on the one line program just established. It is developed as follows:
7. Write your one-line, looping program out into an equivalent multi-line program with the number of lines equal to the number of loops. For example, a one line, 4 loop program with the values:

	HEAT	PULL	VELOCITY	TIME
loops 4 times	285	0	45	150

would be written into an equivalent 4 line program:

	HEAT	PULL	VELOCITY	TIME
line 1	285	0	45	150
line 2	285	0	45	150
line 3	285	0	45	150
line 4	285	0	45	150

8. Now, you can make adjustments to the last or next to last line to fine tune the program and the resulting pipette.
9. Recommended changes to fine tune the multi-line program:

For larger diameter tips

Decrease HEAT in **last line**.

For smaller diameter tips

Increase or decrease VELOCITY in **next to last** line by 5 to 10 units, or increase/decrease VELOCITY in **last line** by 5 to 10 units, or add a small amount of PULL (10 to 20) to **last line**.

## Technical tips for pulling micropipettes

### Regulating the time it takes to pull a sharp pipette

**HEAT.** For 1.0mm O.D. tubing, if the pull takes longer than eight seconds and you are trying to pull a fine micropipette, increase the HEAT. To do this in a methodical fashion, increase the HEAT value in five unit increments, each time monitoring pull time until the pull takes place in less than eight seconds.

If the pull occurs in less than three seconds after you start, decrease the HEAT value in a similar fashion.

For 2mm O.D. tubing, the pull should occur between 15 and 25 seconds after the start. Make corrections as outlined above for smaller tubing.

**Pipette Position.** The position of the glass within the filament will also affect the time it takes to pull a pipette. When using a trough filament the glass should be about 0.5mm above the bottom of the filament and centered front to back. In the case of a box filament the glass should be in the center of the filament. Filament positioning is covered in the next section of this manual "Heating Filaments".

### Regulating the length and tip size of a sharp pipette

**HEAT.** Higher HEAT settings will give longer and finer tips. A HEAT value equal to the Ramp Test value plus 15 will generally give a very fine tip.

It should be noted that at high HEAT settings (filament white-hot) the filament life is greatly reduced. It is suggested that a setting equal to the ramp value plus 15 is used initially and electrode length is controlled by air pressure adjustments. If this is insufficient, filament width can be varied.

**Filament width.** Filaments narrower than 2mm can not form as fine a tip as the wider filaments. The tip size will decrease with increasing filament width until a width of 3mm is reached. Increasing the filament width beyond 3mm will produce longer tips with a more gradual taper (which may penetrate better in some cases). The tip, however, will not be any smaller.

Tips of 1-2 $\mu$ m can be formed using a 1.5mm filament with low filament temperatures and weak PULL strengths.

**Air flow.** In general, electrodes will not be formed if the air pressure is set too high. It is thus recommended that the front panel pressure adjustment be set to standardized values of 500 for thick walled glass and 300 for thin walled tubing. However, as outlined above, under **Micropipette/microinjection needle fabrication**, the length of pipette tips can be controlled by varying air pressure. Furthermore, when making patch pipettes, if increasing TIME to its maximal setting of 255 does not provide enough cooling to produce tips with a short enough taper, then increasing pressure above the standard values may be warranted.

**DELAY mode of active cooling.** As discussed in detail on page 30 of this manual, switching from the TIME to the DELAY mode of active cooling may give more precise control, and a wider range of control, over the length (or taper) of a sharp pipette tip. The delay mode is often employed when using thick walled glass or for programs designed for the fabrication of pronuclear injection needles.

## Fire Polishing

The P-97 micropipette puller allows you to perform pseudo fire-polishing of pipette tips but does not have a provision for visualizing the pipette tip during the heating process. The extent of the heating required to attain the desired degree of polishing must be empirically established.

What distinguishes a program for polishing from other programs used to pull pipettes is the use of a Velocity value of 0. To program the instrument for the fire-polishing mode, try entering a program as follows:

HEAT	PULL	VELOCITY	TIME
Ramp value	0	0	250

Pressure does not matter because the air supply is never activated in this mode.

When executed, this program will behave as follows: the Heat will turn on for the duration set by Time. Each Time unit is equivalent to 10 msec. Therefore in the above program, the Heat will turn on for 2.5 seconds.

The procedure for polishing is as follows:

- 1) Pull a pair of pipettes with the desired pulling program. After the pipettes have been pulled, keep them clamped in the puller bars.
- 2) Reset the puller and select your polishing program (as above).
- 3) Manually push the puller bar (with the installed pipette) back towards the filament, or use the Fire Polish Spacer block described below. Try positioning the tip of the pipette just inside the edge of the filament.
- 4) Press Pull and the filament will heat up for 2.5 seconds, exerting a polish on the end of the pipette.

How much polishing occurs will be a function of the Heat value and the duration of that Heat as determined by the Time value. You may need to execute the program multiple times to achieve an appropriate polish. You will need to experimentally establish how much Heat and how much Time is necessary for the degree of polishing you require.

The most difficult part of this procedure is manually positioning each pipette back into the filament at the same relative position each time. The Fire Polishing Spacer allows you to consistently reposition the pipette within the filament. The T-shaped aluminum Spacer has an adjustable set screw protruding from it.

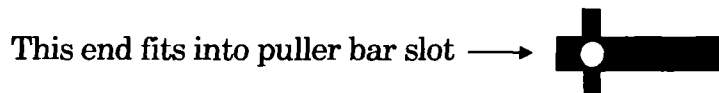

**Figure 19: Side View of Fire Polishing Spacer**

The Spacer/screw combination fits into the slot in the puller bar and fixes the puller bar position. You adjust the screw position to set the position of the puller bar (and thus the pipette tip). The more extended the screw is, the closer the pipette tip will be to the heating filament.

When you have finished polishing the pipette, remove the Spacer from the puller bar.



## LEFT PULLER BAR

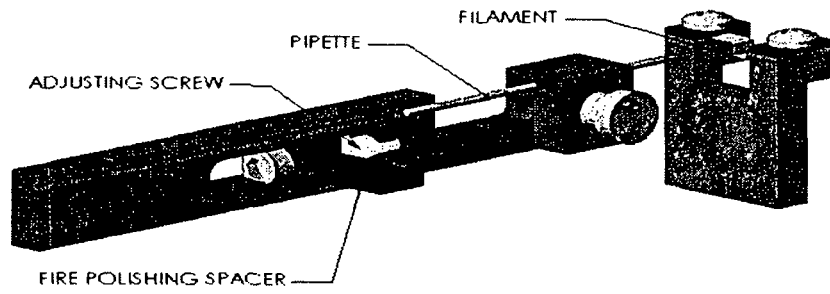

**Figure 20: Fire Polish Spacer in Puller Bar**

## HEATING FILAMENTS

### General Information

The pipette programs that you ultimately develop will largely depend on the type of heating filament installed in the puller and the glass that you use. Depending on your research application, there may be an optimum filament/glass combination which differs from the configuration the puller is currently set up with. After reading through the following material, if you have questions about which filament to use for your application, contact our technical support staff.

### Trough Filament

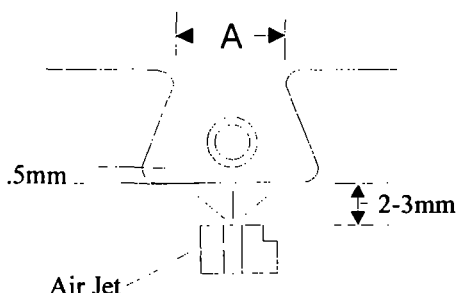

**Figure 21. End View of Trough Filament and Glass**

The trough filament is a general-purpose filament. It is recommended for standard or thin wall glasses used for patch pipette fabrication, sharp electrodes with short tapers, and some types of microinjection needles. The geometry of the trough allows the filament to cool rapidly during the cooling phase of the pulling process.

### Positioning

When using the trough filaments, the glass tubing should be positioned just above the bottom of the filament (approx. 0.5mm) and centered between the two sides (**Figure 21**). This position can be adjusted by using the two eccentric chrome screws located on the aluminum angle piece that holds the filament assembly (**A and B in Figure 4**). First loosen the two locking screws (**A' and B' in Figure 4**) and then the filament can be moved in relation to the glass tubing by turning the appropriate eccentric chrome screw (**A or B in Figure 4**). See the Filament Replacement section of the Maintenance Chapter for a full description of this adjustment.

### Geometry

The geometry of the trough filament is an important factor for proper heat application to the glass. Replacement trough filaments should have a profile similar to that illustrated in **Figure 21**, where the distance between the top corners (distance A) is approximately 2/3 the length of the bottom of the filament. This geometry will provide improved heat distribution to the top of the glass tubing. When replacing a filament, check the new filament geometry. If it differs appreciably from the ideal, you can easily modify it by grasping the bottom corners with non-serrated forceps and gently pushing on the horizontal 'wings'.

The trough filament you select depends upon the length of the taper that you want. Wider filaments for special purposes are available upon request.

Filament	Description
FT315B	1.5mm wide trough
FT320B	2mm wide trough
<b>FT330B</b>	<b>3mm wide trough</b>
FT345B	4.5mm wide trough

**Table 3. Trough Filament Sizes**

## Box Filament

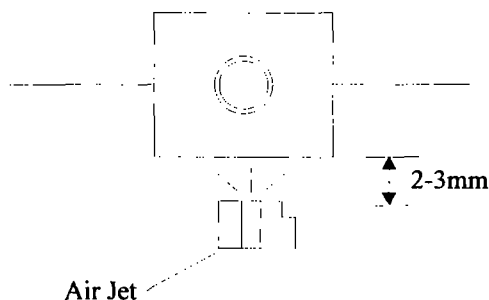

**Figure 22. End View of Box Filament**

Another type of filament that can be used is the box type heater filament. The box filament heats the glass in a more symmetrical fashion than trough filaments, so that the pipettes produced tend to be more straight and concentric than those pulled with a trough filament. It delivers more heat to the glass resulting in faster heating without the necessity of increasing the temperature of the filament. **Note:** The Ramp Test value with a box filament will be higher than that with the trough filament, thus program HEAT values will be correspondingly higher in order to reach similar operating temperatures.

Box filaments are recommended for the following micropipettes:

**Microelectrodes used for slice preparations where long, parallel walls would aid penetration**

**Microinjection needles for transgenic research**

**Microdissection tools**

**Thick or multi-barrelled glass**

**Aluminosilicate glass**

The box filament has two primary limitations.

First, it requires more current to heat to a given temperature than the same size trough filament. Thus it is possible to use wider trough filaments without exceeding the maximum current capacity of the puller.

Second, the box configuration reduces the cooling effect of the air jet. For this reason the box filament is sometimes not recommended when very short pipettes are to be formed.

### Positioning

When using a box filament, the glass tubing should be centered vertically and horizontally (**Figure 22**). This position can be adjusted as described above for the trough filament. See **Figure 21**, and the Filament Replacement section of the Maintenance section for a full description of this adjustment.

### Geometry

The box size you select should be approximately 1.0 to 1.5mm larger than the outside diameter of the glass you are using. The width of the filament will depend on the research application. A good general-purpose box filament is the 2.5mm wide, 2.5mm high and 2.5mm deep filament (**FB255B**). Special box filaments made to accommodate larger diameter glass or special pulling applications are available upon request.

Filament	Description	Glass O.D.
FB215B	2mm square x 1.5mm wide	1.0mm
FB220B	2mm square x 2.0mm wide	1.0mm
FB230B	2mm square x 3.0mm wide	1.0mm
<b>FB255B</b>	<b>2.5mm square x 2.5mm wide</b>	<b>≤ 1.5mm</b>
FB245B	2.5mm square x 4.5mm wide	≤ 1.5mm
FB315B	3mm square box x 1.5mm wide	≤ 2.0mm or 2-3 barrels
FB320B	3mm square box x 2.0mm wide	≤ 2.0mm or 2-3 barrels
FB330B	3mm square box x 3.0mm wide	≤ 2.0mm or 2-3 barrels

**Table 4. Box Filament sizes**

## MAINTENANCE

### Cleaning

To maintain the P-97 in optimal condition the vinyl dust cover that is shipped with the P-97 should be used whenever the unit is turned off to protect the puller from dust and spills.

Occasionally clean the exterior and the base plate of the unit by wiping them with a dry cloth to remove dust and fine pieces of glass. Avoid contact with the filament.

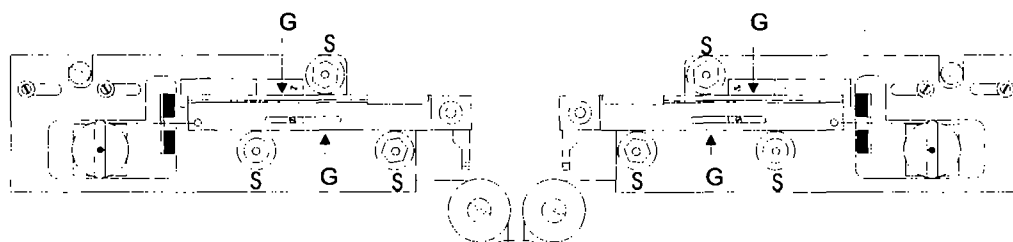

Figure 23. V-groove Bearings and Puller Bars

Occasionally the V-groove bearings (**S in Figure 23**) and the edges of the pull bars which slide in their grooves (**G in Figure 23**) must be cleaned to maintain reproducibility from pull to pull. This should be done using a dry cotton swab. **DO NOT** lubricate any components of the P-97!

### Heating filament replacement

**Filament replacement.** First remove the chamber that encloses the heating filament. This is done by removing the black thumb screw at the lower left corner of the Plexiglas coverplate and then pulling the chamber straight off. The old heating filament can then be easily removed by loosening the two clamp screws (**D' in Figure 24, only one shown**) that hold it in place. Slide out the old filament, slip in a new one and center it over the air jet. Then re-tighten the two clamp screws.

**Air jet position.** The air jet should be from 2-3mm below the center of the filament. If it not within this specification, then loosen the screw holding the air jet in place and reposition it.

**Positioning the glass capillary in relation to the filament.** The correct position of the glass capillary in each of the two filament types is shown above in the Heating Filament section. This positioning is critical to achieving the desired pipette tip size and shape and will almost certainly require adjustment after replacing a filament. To make this adjustment:

1. Carefully slide the glass to be used along the V-groove in the puller bar and see where it is positioned relative to the filament.
2. Locate the aluminum angle plate to the right of the filament assembly and behind the right carrier bar. Two chrome eccentric screws (**A and B in Figure 24**) in slots are mounted on this bracket, one located on the vertical face of the bracket and one on the horizontal face.

Identify the flathead locking screws to the right of each chrome screw.

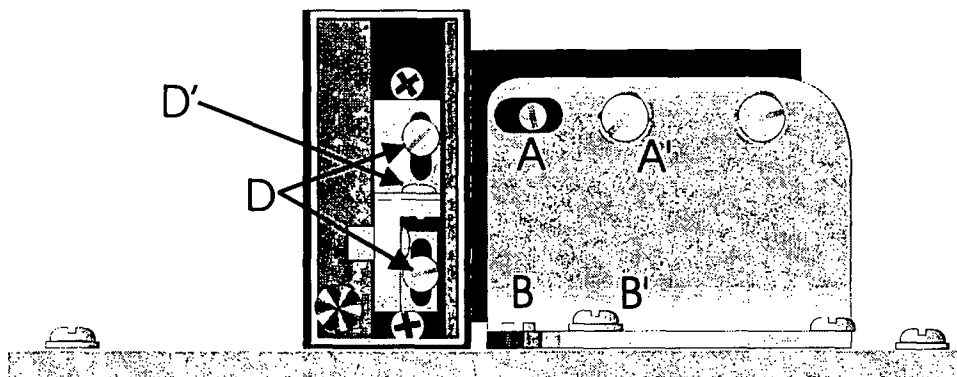

**Figure 24. Filament Alignment**

3. Loosen the locking screws (**A' and B'**)
4. Turn the eccentric chrome screw (**A**) on the vertical face to adjust the vertical position of the filament and the eccentric chrome screw (**B**) on the horizontal face to adjust the front-to-back position of the filament.
5. Tighten the locking screws (**A' and B'**)
6. If the vertical excursion available with the vertical cam screw isn't enough to center the glass, you will need to reposition the upper and lower heater jaw assemblies by first loosening the brass screws holding the jaws to the black nylon (**D**). Reposition the jaws then retighten the brass screws and re-position the air jet.

**Testing the position.** After positioning the filament it is important to determine if the filament is centered left-to-right over the air jet.

Run a RAMP TEST with your glass and the new filament. If you are unclear as to how to run the ramp test, please review that section of the Control Functions Chapter of this manual.

Program a one line program similar to the following:

HEAT	PULL	VELOCITY	TIME	PRESSURE
Ramp	120	100	150	500

This program is only being used to test pipette length. Pull a pair of pipettes. Remove the pipettes from the carrier bars and hold them side by side as shown in the figure below. If the shanks of the pipettes vary in length, this is an indication that the filament is not centered left to right relative to the air jet, thus one pipette is "seeing" more cooling than the other. Loosen the filament clamping screws and move the filament very slightly towards the side that produced the shorter pipette. Then tighten up the clamps and try another pull. You may have to go through several iterations before you get it centered properly.

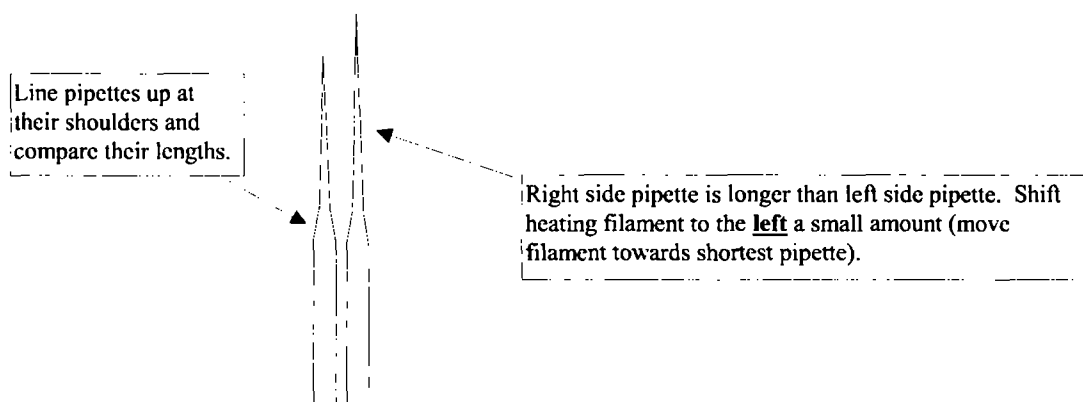
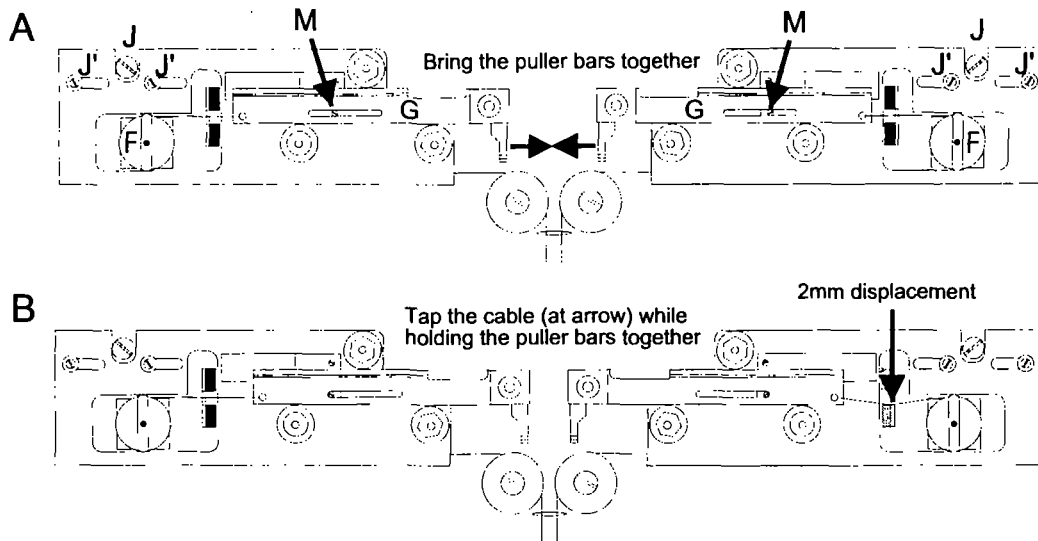

**Figure 25. Micropipette Shapes**

### **Pulley Adjustment**

The position of the two pulleys (**F in Figure 26A**) which carry the cables from the solenoid (**not shown**) to the carriers (**G in Figure 26A**) is adjustable. The pulley position controls the tension of the cables. A difference between the tension of the two cables can cause problems with pipette reproducibility and/or a disparity between the taper length of the pair of pulled pipettes (as illustrated in Figure 25). Taper length inequality is generally caused by the air jet not being aimed at the center of the filament, so to avoid unnecessary adjustments to the pulleys, be certain that the filament and air jet are correctly positioned before proceeding.

The pulley adjustment is made by moving one or both of the pulleys to equalize the tension on the two cables. There are two sets of stops in the system; the stops in the carrier slots against which the carriers rest (**M in Figure 26A**), and a stop to prevent the solenoid from being pulled out of its housing (**not shown**). The adjustment of the pulleys must be made so that the carriers will still come up against their stops while the solenoid is not against its stop. The two cables should not be under high tension when the carriers are against their stops (the position they would be in just before pulling an electrode).



**Figure 26. Pulley Adjustment**

Holding the puller bars together with one hand, you should be able to press on either cable between the carrier and the pulley and feel about 2mm of deflection (**Figure 26B**) before the solenoid hits its stop. If the deflection is more or less, the pulley position should be changed. This is done by loosening the two screws above the pulley (**J' in Figure 26A**) and turning the chrome eccentric screws (**J in Figure 26A**) to move the pulley in small increments until the two cables are of equal tension. If the carrier no longer stops against its stop in the slot (**M in Figure 26A**), but stops against the cable, then the cam must be adjusted back until the carrier once more hits its stop. It is important that the carriers come up against their stops without significant tension on the cables. If there is too much tension, the initial pull will depend on how tightly you hold the finger stops when the glass is clamped in the carriers. If this happens, the electrodes will not be consistent from pull to pull.

### Regeneration of Drierite granules

The Indicating Drierite found in the canister at the right rear corner of the base plate on the P-97 is a desiccant made of calcium sulfate (97%) and cobalt chloride (3%). This material is used to remove water vapor from the air-cooling supply system. As it absorbs more moisture it becomes pink in color and must eventually be "regenerated" (dried).

Before proceeding, make sure the puller is off and unplug the power cord. To remove the canister from the P-97, first remove the plastic puller cover by loosening the three screws that hold it down. Next, slide the input (left) and output (right) air tubes off their white plastic connectors on the canister. Finally, the two black plastic clamps which secure the canister to the baseplate can be released by forcing one half of the connector out of the other half at the point where they meet. The canister can be removed.

Unscrew the aluminum end cap, being careful not to loose the black rubber sealing ring that forms the airtight seal under the cap. With the cap off, the spring, its associated aluminum keeper and the first filter can be removed exposing the Drierite. The exhausted granules can then be removed from the canister. The far filter can then also be removed. There is no reason to remove the far aluminum keeper. The Drierite should be spread evenly, one granule deep, on a tray and heated for one hour at about 200 degrees Celsius. The granules should



then be cooled in a tight container before refilling the plastic canister. Filters should also be pre-dried at 100°C for about 30 minutes before assembly. Drierite is not toxic and can be handled with few precautions. For more detailed safety information please refer to the enclosed MATERIAL SAFETY DATA SHEET.

The Drierite, filters and keepers are installed in the canister in the order they were removed. First install a filter against the keeper which was left in the canister. If this keeper was removed, slide it back in first and make sure that it lays flat against the plastic shoulders in the far end of the canister. With the far keeper and filter in place, pour in the regenerated Drierite. Next insert the second filter followed by the keeper attached to the spring. Finally, lay the rubber seal in the cover and screw on the cover being careful to keep the seal laid out flat as you tighten. There is no need to over tighten the cover, but it should be possible to hear and feel it seating firmly against the rubber seal.

Reinstall the cannister on the puller baseplate with its cover to the left and the air tube connections to the front. The black plastic hold downs slide inside one another and are pushed tight by hand to firmly hold the cannister in place. **At this point, install the air input tube (larger tube, left-hand connector) and stop; do not install the output tube.** Plug in the puller and turn it on. The air pump will turn on and blow air through the cannister. Allow this process to continue for several minutes. This procedure allows the purging of any dust or loose particles of Drierite that may have been produced during the recharging process. **It is critical that this dust not be blown into the output tube where it might clog either the air solenoid or the air jet.** After the purging process, you may connect the output tube and reinstall the puller cover.

If replacement is necessary, Indicating Drierite is manufactured by W.A. Hammond Drierite Co., Ltd. (Xenia, Ohio, USA) and can be purchased from most scientific supply distributors.

## TROUBLESHOOTING

### Controlling pipette tip shapes

#### **Problem: WHAT GLASS SHOULD I USE?**

The type of glass and the wall ratio I.D. (inside diameter) to O.D. (outside diameter) are two of the most important variables in controlling tip size. For example, using borosilicate glass with an O.D. of 1.0mm and an I.D. of 0.50mm will give tips of 0.06 to 0.07mm as demonstrated in Program 0. Using the same settings, borosilicate glass 1.0mm O.D. and 0.78mm I.D. will form tips of 0.1 to 0.12mm. Aluminosilicate glass with an O.D. of 1.0mm and an I.D. of 0.58mm will form tips of 0.03 to 0.04mm again with the same settings.

In general the thicker the wall in relation to the O.D. of the glass the finer the tip will be, and the thinner the wall the larger the tip will be. Thin wall glass will give the best results in most experiments as it will have the largest pore for a given tip size. This means it will have a lower resistance and will allow for easier injection of solutions. However in many cases with small cells the thin wall glass will not form tips fine enough to obtain good penetrations. In this case heavier wall glass must be used.

#### **Problem: THE RESISTANCE OF MY PIPETTES IS TOO LOW. HOW DO I PULL A HIGHER RESISTANCE PIPETTE?**

The first point to note is that there is very little correlation between tip size and electrode resistance. Most of the resistance of a microelectrode is in the shank of the electrode behind the tip. Electrode tips which are 0.1 mm in diameter can vary in resistance from 20MW to 1000MW depending on the length of the electrode and what is used for the filling solution. If the same solution is used then resistance may give an indication of how well the electrode will penetrate a cell as the electrode with the higher resistance will probably have a longer shank and a smaller cone angle at the tip. This combination will aid in the penetration of cells where the cell is not a surface cell.

#### **Problem: OK, BUT I STILL WANT A SMALLER TIP THAN I AM GETTING.**

1. The first thing to try in most cases is to increase the HEAT value. This will generally decrease the tip size but it will also give a longer shank. If the higher resistance is not a problem this is generally the best solution. Continuing to increase the HEAT however, is not the final answer as too high a HEAT can lead to larger tips. In general with 1.0mm O.D.X 0.5mm I.D. borosilicate glass the finest tips will be formed when the glass pulls in 5 to 7 seconds after starting the pull.
2. If the electrode is now too long and results in a resistance too high to pass the necessary current, then the next step is to increase the pull strength. In general a pull strength of 125 will give tips of less than 0.1mm. Increasing the pull to 250 will reduce tip size about 5-10%. We recommend a pull of about 150 in most cases.
3. The last major variable to adjust is the amount of cooling of the glass during the pull. If in the case of 1.0mm O.D. X 0.5mm I.D. borosilicate glass the pull takes place in 5-7 seconds the tip size will not change with a change in the cooling air. The only change will be in the length of the shank. If however the HEAT is such that the pull takes place in more than 8 seconds, decreasing the cooling may somewhat decrease the tip size. Cooling can be most effectively decreased in the P-97 by decreasing air pressure, however a decreasing TIME may also be useful.

**Problem: HOW DO I INCREASE THE SIZE OF MY PATCH-PIPETTE?**

1. The first thing to try is to reduce the HEAT. Try dropping the HEAT 5 units at a time to see if this will increase the size of the tips.
2. If this does not work increase the pressure in units of 50. The PULL should generally be set to 0 when pulling large tipped (1-10 mm) pipettes.
3. See also the step 10 under "Step-by-step patch programming" in the PARAMETER ADJUSTMENT chapter.

**Problem: THE TIPS OF MY PATCH-PIPETTES VARY IN SIZE FROM PULL TO PULL.**

This can happen when a pipette is formed in two or more loops. If the pipette is formed in three loops in one case and then on the next pull it forms in four loops the tips will not be the same. Adding one unit in the VELOCITY value will in most cases cause the pipette to be formed in three loops or subtracting 1 unit should cause the pipette to form in 4 loops. It is always good technique when a program is developed that produces a desired pipette, to try increasing and decreasing the VELOCITY value to be sure that you are in a stable region. The best procedure in developing a very reliable pipette program is to change the VELOCITY value both up and down until the number of cycles to pull the pipette changes. Then pick a value halfway between for the final VELOCITY value.

**Problem: I NEED TO FORM AN INJECTION PIPETTE WITH A 1mm TIP THAT IS 20 TO 50mm LONG. HOW DO I DO THIS?**

Try a program in which the first two lines of the program have a PULL value of 0, a VELOCITY value of 10 to 30, a TIME setting of 200 and use the ramp value for the HEAT (box filament). The third line should have the same HEAT value, a PULL value of 150, a VELOCITY of 30 and the TIME should be between 0 to 50 depending on the tip needed (values may vary depending on glass characteristics).

The idea behind this program is to reduce the size of the glass on the first two cycles and then on the third cycle we give a hard pull with the air turned off. Normally if the air is turned off a long wisp will result, but since we have greatly reduced the size of the glass and with a very hard pull the glass will tend to separate when it is about 1mm in diameter.

**Problem: THE ELECTRODES ARE BENT. HOW DO I MAKE THEM PULL STRAIGHT?**

This problem occurs most often when using the trough filament. Going to a box type of filament will produce straighter pipettes. The bend in the pipette has no effect on the pipette's tip and should cause no problems unless you are penetrating quite deep in the tissue and you are aiming at a certain site. Then the bend may lead the pipette to the wrong area. The box filament is not a complete improvement on the trough filament as the air flow is much less effective with the box filament, and you give up much of the length control that the cooling air gives with the trough filament.

**Problem: ONE ELECTRODE IS MUCH LONGER THAN THE OTHER ELECTRODE.**

This is caused by one of two things.

1. The filament may not be centered over the air jet. If it is not, follow the procedure "Testing the position" in the Heating filament replacement section of the Maintenance chapter.
2. If the filament is correctly centered, then the tension in the two cables which transmit the pulling force from the solenoid to the puller bars is not equal. To check the tension and adjust if necessary, follow the procedure "Pulley Adjustment" in the Maintenance chapter.

**Problem: THE SHAPE AND RESISTANCE OF THE PIPETTE CHANGES FROM PULL TO PULL.**

1. In most cases this is due to one or both of the cables to the pipette carriers being set up too tight. If the cable is adjusted so that the carrier can't come against the stop in the slot in the center of the pipette carrier, then the initial pull tension will depend on how hard the carriers are squeezed together when the glass clamps are tightened. To adjust, see the pulley adjustment section.
2. A second possible cause of this problem is dirt on the carrier bars or bearings. In this case clean the carriers and bearings with a lint free tissue or cloth.
3. If the problem persists than run the ramp test several times. If possible use one long piece of glass and move the glass over after each ramp test. If the ramp values are +/- 4 units or less the problem may be with the glass. If the values are greater than +/- 4 units call Sutter Instruments.

**Controller problems****Problem: THE FILAMENT DOES NOT LIGHT UP WHEN I PRESS PULL.**

There are a number of possible reasons why this might happen.

1. Look and see if the filament has burned out. In some cases it may be necessary to loosen the screws holding the filament in place as a very fine break may be hard to see.
2. If the filament is OK, try running the ramp test and see what happens. If you have just changed the filament it is quite possible that the new filament needs a very different HEAT value than what you have been using. It is always a good idea to run the ramp test each time you change the filament.
3. If you can run a ramp test but can not pull a pipette when using the RAMP value for the heat setting, there might be an air leak. Check to see if the air compressor is running constantly. If so, try to locate the air leak. Check tubing, connections, air solenoid, and the cap of the drierite canister. If the air compressor is not running, it is possible that the air solenoid is stuck closed or the compressor has failed. Contact Sutter Instruments for further instructions.

4. If you run the ramp test and the HEAT value reaches 999 without the filament heating up check the tightness of the exposed connectors in the filament current pathway. These are the filament holding screws, the screws which hold the two brass jaws and the two nuts connecting the filament wires to the posts in back of the filament block.
5. If these connectors are tight then the problem is probably the power FETs on the heat sink.(Contact Sutter Instruments for further instructions.)

**Problem: DISPLAY BLANK, FAN NOT ON.**

1. Check power cord and wall a.c. outlet.
2. If unit is properly plugged in and still does not work, remove the power cord and check the fuse. If the fuse has blown, a failure in components that are not serviceable by the user has likely occurred. Contact Sutter Instrument Company Technical Support.
3. If the fuse is still good, the unit is properly plugged in and it still does not work, a failure in components that are not serviceable by the user has likely occurred. Contact Sutter Instrument Company Technical Support.

**Problem: DISPLAY SHOWS A ROW OF BLOCKS.**

1. The microprocessor has failed to properly initialize the display. This problem can occur when the power has been turned off and then on again too rapidly. Press RESET and the display should show the proper power-up message. Always allow at least 5 seconds before turning the power back on. If the display still shows a row of blocks, a failure in components that are not serviceable by the user has likely occurred. Contact Sutter Instrument Company Technical Support.

**Problem: DISPLAYED PROGRAM VALUES ARE NOT CORRECT**

1. Make sure that values were not changed by another user. Always write down the program values and the ramp-test value and keep them in a secure place.
2. If the values entered are not held when the power is turned off, a failure in components that are not serviceable by the user has likely occurred. Contact Sutter Instrument Company Technical Support.

## **Technical Support**

For further assistance contact Sutter Instrument Technical Support at:

**(415) 883-0128 or [info@sutter.com](mailto:info@sutter.com)**

## FUSE REPLACEMENT

In the event that the controller fails to power up when the power switch is turned on check the line power fuse to see if it has blown. The fuse is located in the fuse holder on the power entry module on the back of the controller. To remove the fuse holder first unplug the power cord from the power entry module. This will reveal a slot just under the edge of the fuse holder. Use a screwdriver to pry the holder straight out of the power entry module.

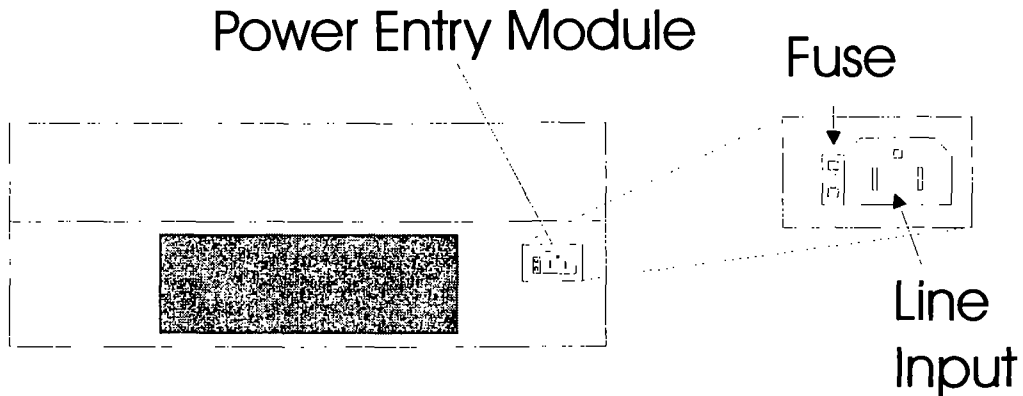

**Figure 27. Power entry module**

The fuse that is readily visible in the fuse holder when you take it out is the one that is “active” when the holder is installed. A spare fuse is also stored within the fuse holder. It is concealed in a compartment as shown in **Figure 28**. To remove the spare fuse, press down on the end of the compartment and push it out of the other end. The old fuse can serve as a convenient tool for pushing the spare fuse compartment out. Replace the active fuse with the spare and re-install the fuse holder and power cord. If the controller fails to power up with the new fuse installed, call Sutter Instrument technical support personnel for assistance.

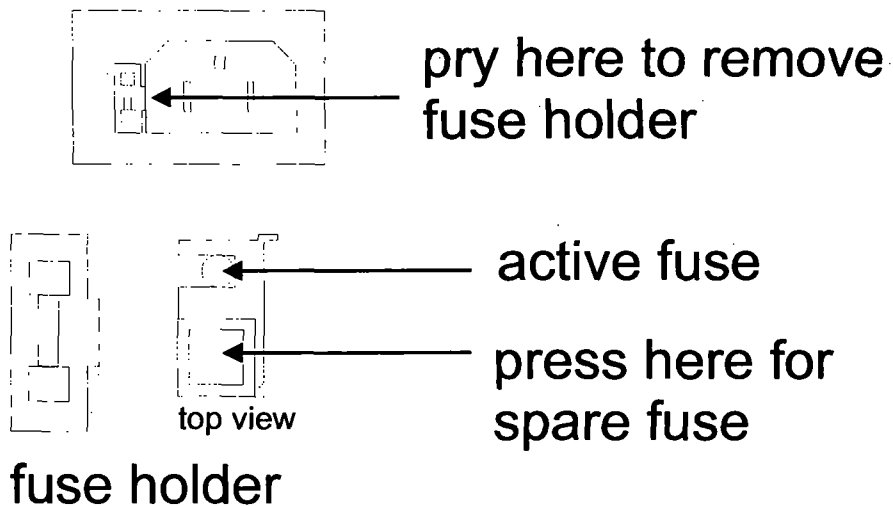

**Figure 28. Fuse holder**

## LIMITED WARRANTY

Sutter Instrument Company, a division of Sutter Instrument Corporation, limits the warranty on this instrument to repair or replacement of defective components for one year after the date of shipment, provided the instrument has been operated in accordance with the instructions outlined in the instruction manual.

Abuse, misuse or unauthorized repairs will void this warranty.

Limited warranty work will be performed only at the factory, the cost of shipment both ways to be borne by the user.

This instrument is designed to pull glass pipettes for use on animal tissues. It is not intended to be used and should not be used in human experimentation or applied to humans in any way.

The limited warranty is as stated above and no implied or inferred liability for direct or consequential damages is intended.

**DISCLAIMER**

The pipette puller Model P-97 is designed for the specific use of creating micropipettes and no other use is recommended.

This instrument creates items which should only be used in a laboratory environment for use on animal tissues. It is not intended to be used and should not be used in human experimentation or applied to humans in any way. This is not a medical device.

Do not open or attempt to repair the instrument without expressed and explicit instructions from Sutter Instrument Company. Extreme heat and high voltages are present and could cause injury.

Do not allow unauthorized and or untrained operatives to use this device.

Any misuse will be the sole responsibility of the user/owner and Sutter Instruments assumes no implied or inferred liability for direct or consequential damages from this instrument if it is operated or used in any way other than for which it is designed.



## TECHNICAL SPECIFICATIONS

<b>Dimensions (H x W x D):</b>	12" x 21" x 14" 30cm x 53cm 36cm
<b>Weight:</b>	60 lb. 28 kg
<b>Electrical:</b>	
Mains voltage	115 V, 60 Hz
Maximum power consumption	370 VA
Mains fuse (rear of cabinet) at 115V	Type T (slow blow), 3A, 250V, GMC
Internal safety fuses (not operator accessible)	
red line	Type T (slow blow), 0.5A, 250V, 3AG
red/yellow line	Type T (slow blow), 0.5A, 250V, 3AG
blue line	Type T (slow blow), 2.0A, 250V, 3AG
orange line	Type T (slow blow), 6.25A, 250V, 3AG
Power cord	10A, 250V, with safety ground plug

## APPENDIX: A    DRIERITE MATERIAL SAFETY DATA SHEET

IDENTITY: INDICATING DRIERITE

DATE PREPARED 1-3-96

DESCRIPTION: 1/16" TO 1/4" BLUE GRANULES

### SECTION I

MANUFACTURER'S NAME:            W.A. HAMMOND DRIERITE CO. LTD.  
 ADDRESS:                            P.O. BOX 460,  
    138 DAYTON AVE.,  
    XENIA, OH 45385  
 EMERGENCY PHONE NUMBER: (513) 376-2927  
 INFORMATION PHONE NUMBER:    (513) 376-2927

### SECTION II

#### INGREDIENTS

CHEMICAL IDENTITY	%	OSHA PEL	ACGIH TLV	UNITS	C.A.S. #
CALCIUM SULFATE	97	15	10	mg/M <sup>3</sup>	7778-18-9
COBALT CHLORIDE	3	0.05*	0.05*	mg/M <sup>3</sup>	7646-79-9

\* (AS COBALT METAL)

#### HAZARDOUS MATERIALS IDENTIFICATION SYSTEM (HMIS)

HEALTH	FLAMMABILITY	REACTIVITY	PROTECTIVE EQUIPMENT
1	0	1	E

### SECTION III

#### PHYSICAL/CHEMICAL CHARACTERISTICS

SPECIFIC GRAVITY: (H<sub>2</sub>O=1):        1.87  
 SOLUBILITY IN WATER:            0.25 GRAMS PER LITER  
 MELTING POINT:                    1450° C DECOMPOSES  
 APPEARANCE:                        BLUE GRANULES; NO ODOR

### SECTION IV

#### FIRE AND EXPLOSION HAZARD DATA

FLASH POINT:                        NONE  
 EXTINGUISHING MEDIA:            NOT COMBUSTIBLE  
 SPECIAL FIREFIGHTING PROCEDURES: NONE  
 UNUSUAL FIRE AND EXPLOSION HAZARDS: NONE

### SECTION V

#### REACTIVITY DATA

STABILITY:                            STABLE  
 INCOMPATIBILITY (MATERIALS TO AVOID): STRONG ACIDS  
 HAZARDOUS DECOMPOSITION BYPRODUCTS: Cl<sub>2</sub> @ 318°C; SO<sub>3</sub> @ 1450°C  
 HAZARDOUS POLYMERIZATION:      WILL NOT OCCUR

### SECTION VI

#### HEALTH HAZARD DATA

EYES: PARTICLES MAY CAUSE IRRITATION.  
 SKIN: THIS MATERIAL IS NOT TOXIC. MAY DRY OR IRRITATE SKIN  
 INHALATION: MAY CAUSE AN IRRITATION OF RESPIRATORY ORGANS OF SENSITIVE PERSONS RESULTING IN THE OBSTRUCTION OF AIRWAYS WITH SHORTNESS OF BREATH.  
 INGESTION: MAY CAUSE VOMITING, DIARRHEA AND SENSATION OF WARMTH

**SIGNS AND SYMPTOMS OF OVER EXPOSURE:** EYE, NOSE, THROAT, OR RESPIRATORY IRRITATION

**CARCINOGENICITY OF INGREDIENTS:**

MATERIAL	IARC	NTP	OSHA
CALCIUM SULFATE	NOT LISTED	NOT LISTED	NOT LISTED
COBALT CHLORIDE	YES*	NO	NO

\*(COBALT & COBALT COMPOUNDS ARE CLASSIFIED AS GROUP 2B)

**MEDICAL CONDITIONS GENERALLY AGGRAVATED BY EXPOSURE:**

PRE-EXISTING UPPER RESPIRATORY AND LUNG DISEASE SUCH AS, BUT NOT LIMITED TO, BRONCHITIS, EMPHYSEMA & ASTHMA

**EMERGENCY AND FIRST AID PROCEDURES:**

EYES: FLUSH WITH WATER  
 DUST INHALATION: REMOVE TO FRESH AIR  
 SKIN: WASH WITH WATER  
 INGESTION: NONE KNOWN

## SECTION VII SPILL OR LEAK PROCEDURES

**STEPS TO BE TAKEN IN CASE MATERIAL IS RELEASED OR SPILLED:**

SWEEP OR VACUUM MATERIAL INTO APPROPRIATE WASTE CONTAINER FOR DISPOSAL. AVOID DUSTING CONDITIONS.

**WASTE DISPOSAL METHOD:** THIS MATERIAL CAN BE DISPOSED OF AS AN INERT SOLID WASTE IN AN APPROVED LAND FILL OR BY OTHER PROCEDURES ACCEPTABLE UNDER FEDERAL, STATE AND LOCAL REGULATIONS.

**PRECAUTIONS TO BE TAKEN IN HANDLING AND STORING:**

KEEP CONTAINER CLOSED  
 STORE IN A COOL DRY PLACE  
 AVOID GENERATING DUST

## SECTION VIII CONTROL MEASURES

**RESPIRATORY PROTECTION:** NIOSH/OSHA APPROVED FOR DUST

**VENTILATION:** TO MEET TLV REQUIREMENTS

**EYES:** SAFETY GLASSES OR GOGGLES

**OTHER PROTECTIVE EQUIPMENT:** GLOVES OR PROTECTIVE CLOTHING ARE NOT USUALLY NECESSARY BUT MAY BE DESIRABLE IN SPECIFIC WORK SITUATIONS.

## SECTION IX REFERENCES

U.S. DEPARTMENT OF LABOR - OSHA FORM APPROVED OMB NO.1218 -0072.

OSHA HAZARD COMMUNICATION STANDARD 29 CFR 1910.1200

U. S. GYPSUM CO.

Although the information and recommendation set forth herein are presented in good faith and believed to be correct as of the date hereof, the W.A. Hammond DRIERITE Co. makes no representation as to the completeness or accuracy thereof. Information is supplied upon the condition that the person receiving same will make their own determination as to its suitability for their purpose prior to use. In no event will the W.A. Hammond DRIERITE Co. be responsible for damages of any nature whatsoever resulting from the use of or reliance upon information herein supplied. No representations or warranties, either expressed or implied, of merchantability, fitness for a particular purpose or of any other nature are made hereunder with respect to information or the product to which information refers.

## INDEX

- |  |   |
|--|---|
| <b>A</b>                                       | <b>D</b>                                |
| air  | date ..... 11                           |
| compressor ..... 13                            | reset (time/date) ..... 26              |
| air jet ..... 13,41                            | default configuration ..... 20,24-26    |
| air jet adjustment/alignment ..... 13,38,39,41 | delay                                   |
| reservoir tank (drierite cannister) ..... 13   | definition ..... 12,18                  |
| solenoid (reedex valve) ..... 13               | special condition ..... 18              |
| air mode ..... 25                              | dimensions (puller/instrument) ..... 53 |
| delay ..... 12,18,25,30                        | of glass ..... 1                        |
| time ..... 12,18,25,30                         | disclaimer ..... 52                     |
| air pressure                                   | display ..... 10,11,48,49               |
| ..... 24,31,33,35                              | Drierite regeneration ..... 44,45       |
| air time at start of pull ..... 26             | Drierite material datasheet ..... 54,55 |
| air time at end of pull ..... 26               |   |
| angle plate ..... 14                           | <b>E</b>                                |
| <b>B</b>                                       | eccentrics                              |
| base ..... 16                                  | cable/pulley ..... 44                   |
| baseplate ..... 16                             | filament alignment ..... 15,38,42       |
| box filaments ..... 39,40                      | <b>F</b>                                |
| bumpers ..... 15                               | features new ..... 1,2                  |
| <b>C</b>                                       | filament adjustment ..... 14,15,42      |
| cable(s) ..... 16                              | filament block ..... 14,42              |
| tension adjustment ..... 43,44                 | filaments ..... 38-40                   |
| cable pulley assembly ..... 15                 | box ..... 39                            |
| bumpers ..... 15                               | burning out ..... 5,24,25               |
| cable ..... 16                                 | geometry ..... 38-40                    |
| pull bars ..... 41                             | positioning ..... 38-40                 |
| puller bars ..... 16                           | item numbers ..... 38-40                |
| spring stops ..... 15                          | replacement ..... 41,42                 |
| V-bearings ..... 16,41                         | trough ..... 38,39                      |
| cables ..... 43,44                             | fire polish ..... 36,37                 |
| chamber ..... 1,14,23,26,41                    | fuse                                    |
| control functions ..... 23                     | holder ..... 50                         |
| air mode ..... 25                              | location ..... 7,50                     |
| air pressure ..... 24                          | replacement ..... 49,50                 |
| air time at start of pull ..... 26             | spare ..... 50                          |
| air time at end of pull ..... 26               | fuses, replacement                      |
| memory test ..... 26                           | internal ..... 53                       |
| ramp test ..... 24                             | mains ..... 53                          |
| reset time/date ..... 26                       | <b>G</b>                                |
| write protection ..... 26                      | general information ..... 1             |
| controls front panel ..... 10                  | glass dimensions ..... 1,5,46           |
| cover plate ..... 14,15                        | glass capillaries                       |
| cycle definition ..... 11,17,19                | alignment ..... 35,39                   |
|  | loading ..... 8                         |
|  | precautions ..... 4                     |
|  | specifications ..... 5                  |

<b>H</b>		<b>P</b>	
heat definition .....	11,17	P80-PC programs.....	25
heat value optimal setting .....	8,24	P-87 programs.....	25
heater jaws .....	14,41,42	panels, L/R.....	15
heating assembly.....	14	parameter adjustment.....	29
angle plate .....	14,42	Patch pipette fabrication.....	31-34
chamber .....	14,23,26	patch pipettes.....	9,17,28,31-34
cover plate .....	14,15	power consumption.....	53
filament block .....	14,42	power cord mains.....	53
heater jaws .....	14,41,42	power entry module .....	7,50
humidity control chamber .....	1,14,25,26	power switch .....	7
removal .....	14	pressure .....	11,35
heating filaments.....	<i>See filaments</i>	program	
<b>I</b>		clearing .....	21
ID (inner diameter of glass) .....	1	default configuration .....	20,24-26
injection pipettes .....	29	definition .....	11,17
<b>K</b>		display .....	11,20
keypad.....	10	editing .....	22
keys		memory .....	28
CLR.....	10,21	parameters .....	11,12,17,18,29-31
ENTR .....	10	selection .....	8,9,20
LAST .....	10,21	viewing.....	21
NEXT .....	10,21	write protection .....	11,26
numeric .....	10	pull definition.....	12,17
PULL .....	10	pull cycle.....	19
reset .....	10	pull time.....	35
STOP .....	10	puller bar(s).....	8,15,16
<b>L</b>		adjustment .....	16
line power (mains) .....	7,53	alignment .....	15
locked/unlocked .....	11,23,26	pulleys adjustment.....	41,42,48
loop/looping .....	27,28,32-34,47	<b>R</b>	
<b>M</b>		ramp test .....	8,23,24,27,33,39,42
mains.....	7	performing a ramp test .....	24
fuses .....	49,51	reset .....	9,10,24,49
power consumption .....	4,53	<b>S</b>	
power cord .....	7,48,50	safety warnings.....	3
voltage .....	4,53	spring stops.....	15
memory .....	23,26,28	<b>T</b>	
memory test .....	23,26	technical specifications.....	53
microinjection needle fabrication.....	29,35	technical support .....	1,49
microinjection pipettes .....	29,35	time mode .....	11,12,18,19,23,25,30,33
microperfusion pipettes.....	18	definition .....	12,18
<b>O</b>		reset .....	26
OD.....	1,46	special condition .....	18
operation.....	4,7-9,27-28	tip shape(s) .....	34,35,46,48
first time use .....	8-9	tip size.....	35
precautions .....	4	troubleshooting.....	46-49
		trough filaments.....	24,29,38,39

*U*

unlock.....11,23,26  
unpacking.....6

*V*

V-bearings .....15,16,41  
velocity .....28,30,32-34  
    definition ..... 12,17  
    special condition ..... 17  
voltage mains.....4,53

*W*

warranty.....51  
weight ..... 53  
write protection.....11,23,26